

BSS222 | **bodhi**

1" x 2-1/4" LED luminaire, remote driver

Project: _____ Type: _____

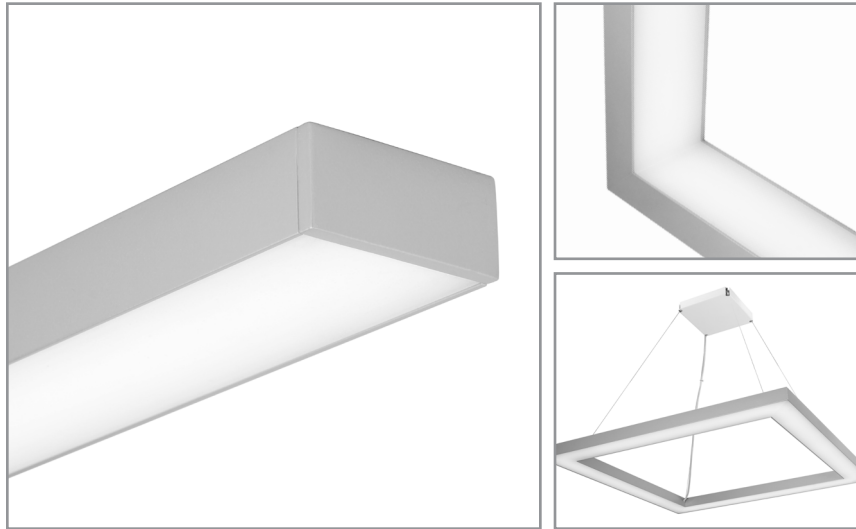

FEATURES

The Bodhi BSS222 is a remote driven luminaire for general lighting use with a shallow profile of 1" tall by 2-1/4" wide. The extruded aluminum fixture is available for surface, t-grid ceiling and cable suspended mounting. In addition to straight fixture configurations, left, right, and inside corners are available as well as a variety of rectangular shapes.

SPECIFICATIONS

Fixture constructed of an extruded aluminum housing, extruded acrylic lens and machined aluminum end caps.

Model variations offered for surface, t-grid ceiling and cable suspended applications.

Standard finishes as shown below.

Available in nominal lengths of 2'-8' single fixtures, continuous runs, corners and rectangular shapes.

Included standard remote 120-277V driver offered with 0-10V dimming or non-dim.

Remote mounted emergency battery backup available (ordered separately, consult factory for details).

Standard light outputs are 675 and 915 lumens per foot.

LEDs available in 2700K, 3000K, 3500K and 4000K, within a 3 step MacAdam ellipse, all with 90+ CRI typical.

Life: 50,000 hours L₇₀.

Limited five year warranty.

UL and C-UL listed for dry and damp locations.

SECTION

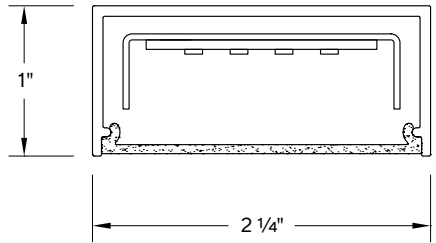

PERFORMANCE

Note: All data reflects fixtures with 3500K LEDs.

NOMINAL LENGTH	OUTPUT	LUMENS/ft.	WATTS/ft.	LUMINAIRE LUMENS	EFFICACY (LPW)
4'	R: regular	675	7.4	2727	92
	H: high	915	10.2	3703	90



BSS222 -

<p>SHAPE*</p> <p>24: straight 24-1/2"</p> <p>36: straight 36-1/2"</p> <p>48: straight 48-1/2"</p> <p>60: straight 60-1/2"</p> <p>72: straight 72-1/2"</p> <p>84: straight 84-1/2"</p> <p>96: straight 96-1/2"</p> <p>LR: left/right 90° corner</p> <p>IC: 90° inside corner Δ</p> <p>GR22: 2'x2' square ‡</p> <p>GR24: 2'x4' rectangle ‡</p> <p>GR44: 4'x4' square ‡</p> <p>GR48: 4'x8' rectangle ‡</p>	<p>CORRELATED COLOR TEMPERATURE</p> <p>27: 2700K-90+ CRI</p> <p>30: 3000K-90+ CRI</p> <p>35: 3500K-90+ CRI</p> <p>40: 4000K-90+ CRI</p>	<p>DRIVER</p> <p>ND: non-dimming</p> <p>[Dimming]</p> <p>D: 0-10V, 10%</p>	<p>OPTIC</p> <p>A: flush lens</p>	<p>MOUNTING OPTION</p> <p>SM: surface mount</p> <p>T1: T-grid 9/16"</p> <p>T2: T-grid 15/16"</p> <p>C4: cable mount 4' cable length</p> <p>C8: cable mount 8' cable length</p> <p>CF: consult factory for custom mounting</p>	<p>RUN CONFIGURATION**</p> <p>SN: single</p> <p>ST: starter</p> <p>AD: adder</p> <p>TR: terminator</p>	<p>FINISH</p> <p>AW: architectural white (semi-matte)</p> <p>WH: white (semi-gloss)</p> <p>BL: black (semi-matte)</p> <p>MB: matte black</p> <p>ESS: environmental satin silver</p> <p>BZ: bronze</p> <p>PR: primer</p> <p>CF: consult factory for custom finish</p>
		<p>LIGHT OUTPUT (lumens per foot)</p> <p>R: regular – 675</p> <p>H: high – 915</p>	<p>LENS ORIENTATION</p> <p>D: direct</p> <p>I: indirect ‡</p>			<p>SA: satin anodize (may require additional lead time)</p>

Note: Each fixture includes a remote driver matched for fixture length and light output.
 * Actual dimension dependent on shape and run configuration.
 ** Not applicable to corner units or GRxx rectangle shapes.
 ‡ Indirect lens orientation available for C4 or C8 mounting option only.
 Δ Available for SM or T1.

SHAPES

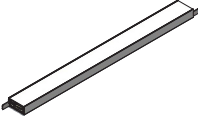
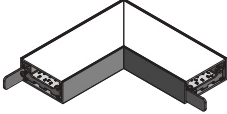
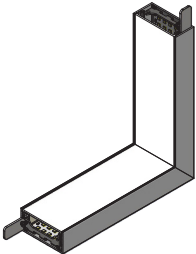
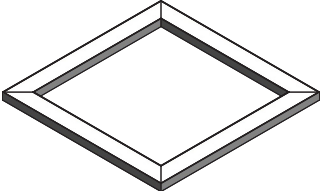
	ORDERING CODE	DESCRIPTION	SPECIFICATIONS
	24, 36, 48, 60, 72, 84, 96	STRAIGHT	<ul style="list-style-type: none"> Available in nominal lengths of 24-1/8", 36-1/8", 48-1/8", 60-1/8", 72-1/8", 84-1/8", 96-1/8".
	LR	LEFT/RIGHT 90° CORNER	<ul style="list-style-type: none"> Fixture provided assembled at 90° angle. Fixture powered by an adjacent straight fixture.
	IC	90° INSIDE CORNER	<ul style="list-style-type: none"> Fixture provided assembled at 90° angle with lenses facing inward. Fixture powered by an adjacent straight fixture. Available for SM, T1 or T2 mounting only
	GR22, GR24, GR44, GR48	SQUARES AND RECTANGLES	<ul style="list-style-type: none"> Fixture assembled in the field in 2'x2' (GR22), 2'x4' (GR24), 4'x4' (GR44), 4'x8' (GR48) nominal rectangular sizes. Available for SM, T1 or T2 mounting only

LENS ORIENTATION

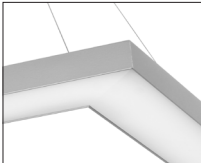
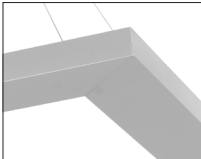
	ORDERING CODE	DESCRIPTION
	D	Direct lens orientation
	I	Indirect lens orientation Available for C4 or C8 mounting option only

MOUNTING

	ORDERING CODE	DESCRIPTION
	SM	<p>SURFACE MOUNT</p> <ul style="list-style-type: none"> • Use appropriate length #8 bugle head fastener through $\varnothing 9/32"$ holes in housing. • 10' low voltage leads exit from the fixture back at an end.
	T1 T2	<p>T-BAR GRID CEILING – $9/16"$ width T-BAR GRID CEILING – $15/16"$ width</p> <ul style="list-style-type: none"> • Housing secures with t-bar clip directly to ceiling grid, without the need for tools. • 10' low voltage leads exit the fixture back at an end.
	C4 and C8	<p>CABLE MOUNT</p> <p>Mounting option includes:</p> <ul style="list-style-type: none"> • $\varnothing 1/32"$ x 48" (C4) or 96" (C8) aircraft cables • 60" (C4) or 108" (C8) low voltage cable (in coordinating finish) • Bracket bars for straight fixture mounting • $\varnothing 5"$ white canopies for straight fixture mounting • 1"H x 6"W x 6"L canopy assembly for squares and rectangles • Canopy mount cable grippers

LENGTH/MOUNTING DIMENSIONS

ORDERING CODE	LENGTH A	LENGTH B	LENGTH C	LENGTH D	LENGTH E
24	24-1/2"	24-5/16"	24-1/8"	-	-
36	36-1/2"	36-5/16"	36-1/8"	-	-
48	48-1/2"	48-5/16"	48-1/8"	-	-
60	60-1/2"	60-5/16"	60-1/8"	-	-
72	72-1/2"	72-5/16"	72-1/8"	-	-
84	84-1/2"	84-5/16"	84-1/8"	-	-
96	96-1/2"	96-5/16"	96-1/8"	-	-
LR	SEE ILLUSTRATION BELOW				
IC	SEE ILLUSTRATION BELOW				
GR22	-	-	-	22-5/8"	22-5/8"
GR24	-	-	-	22-5/8"	46-5/8"
GR44	-	-	-	46-5/8"	46-5/8"
GR48	-	-	-	46-5/8"	94-5/8"

RUN CONFIGURATION INFORMATION

ORDERING CODE	DESCRIPTION
SN	Single
ST	Starter
AD	Adder
TR	Terminator

Note: Not applicable to corner units or GRxx rectangle shapes.

RUN INFORMATION

Back Plan - Surface Mount Single Fixture

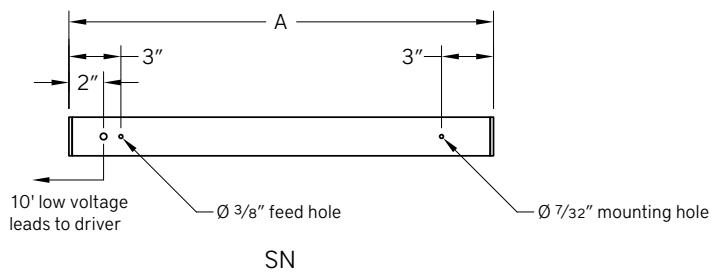

Back Plan - Surface Mount Continuous Run

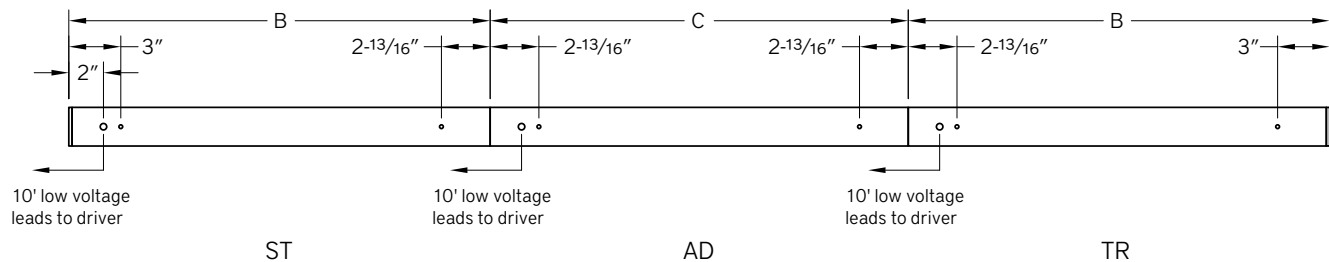

RUN INFORMATION

Side View - Cable Mount Single Fixture

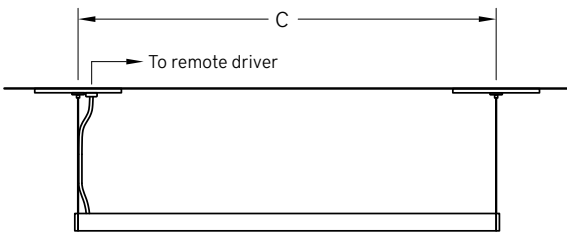

SN

Side View - Cable Mount Continuous Run

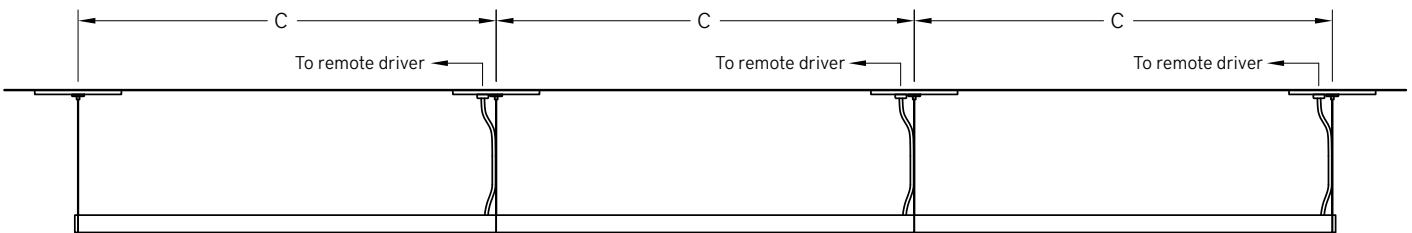

ST

AD

TR

90° Left/Right Corner

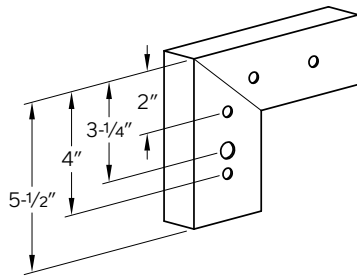

90° Inside Corner

Note: For SM surface or T1 t-grid mount only

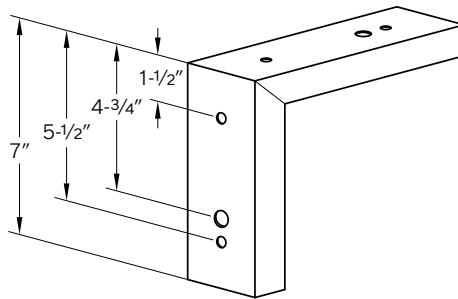

Back Plan - Surface Mount Rectangle

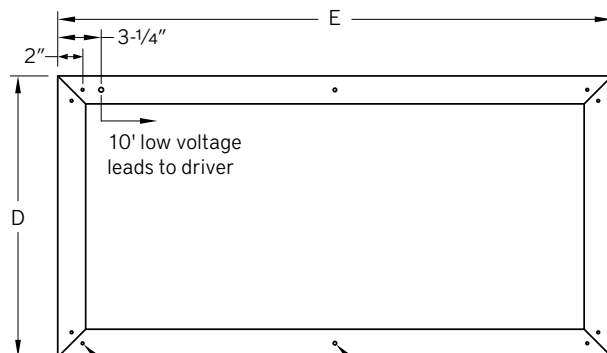
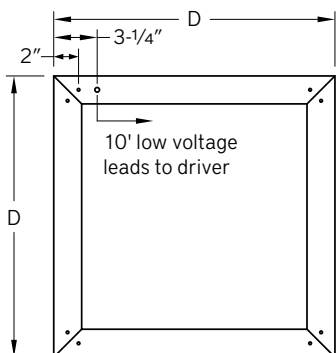

Ø 7/32" mounting hole
Additional mounting holes provided as required for larger shapes

Plan View - Suspended Square

