

Project: _____ Type: _____

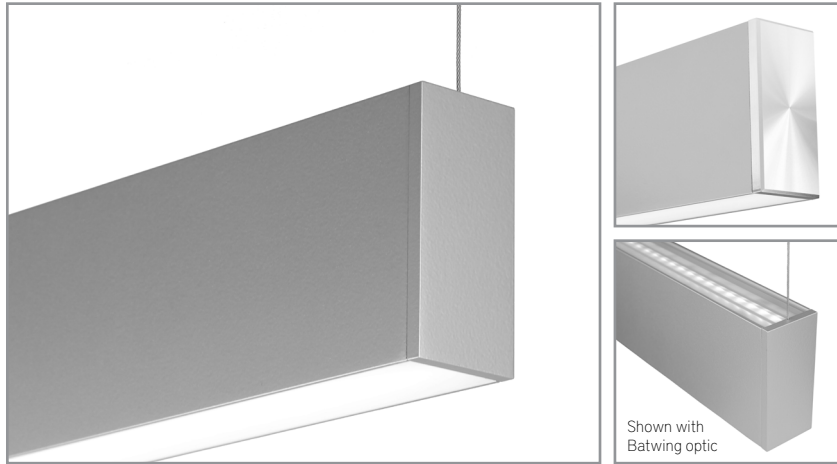

FEATURES

The Grom series GRM30 is a miniature, direct/indirect, linear luminaire for general lighting use. While small in profile, at 1-3/8" wide by 3" tall, the extruded aluminum fixture accepts a variety of popular drivers. Standard 90+ CRI LEDs, dual circuiting, multiple direct lens and indirect optic options enhance application versatility. **Fixture with certain options available for 10-Day QuickShip.**

SPECIFICATIONS

Fixture constructed of an extruded aluminum housing, extruded acrylic lenses and machined aluminum end caps

Fixture provided with minimal, small diameter aircraft cable and hardware

Standard finishes as shown below

Optional end cap with chamfered edges and lathe machined face available in mill aluminum finish

Available in nominal lengths of 2'-8' single fixtures and continuous runs

Standard integral 120-277V driver offered with 0-10V dimming or non-dim (other dimming driver options available)

Remote mounted emergency battery backup available (ordered separately, consult factory for details)

Standard light outputs range from 470 to 640 lumens per foot, depending on optic option

LEDs available in 2700K, 3000K, 3500K and 4000K, within a 3 step MacAdam ellipse, all with 90+ CRI typical

Life: 50,000 hours L₇₀

Limited five year warranty

UL and UL-C listed for dry and damp locations



Highlighted fields denote QuickShip Options. See complete 10-Day QuickShip Terms and Conditions available at www.bartcolighting.com/quickship-products/. Purchase order must reference "QuickShip".

SECTION

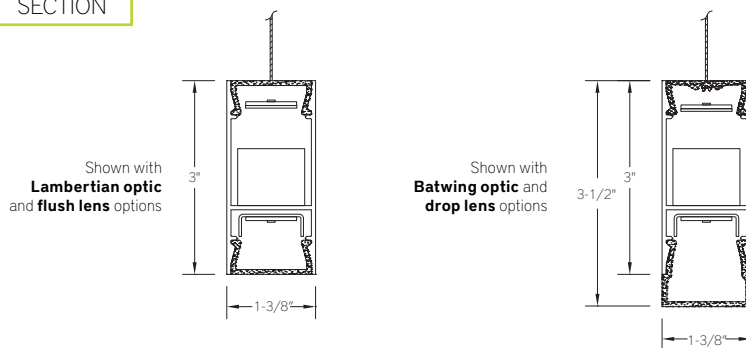

PERFORMANCE

Note: All data reflects fixtures with 3500K LEDs

NOMINAL LENGTH	OPTIC CONFIGURATION	OUTPUT	LUMENS/ft.	WATTS/ft.	LUMINAIRE LUMENS	EFFICACY (LPW)
4'	Indirect - Lambertian	R: regular	500	3.9	2016	129
		H: high	640	5.1	2587	126
	Indirect - batwing	R: regular	550	5.1	2212	108
		H: high	640	6.0	2580	107

OPTIC CONFIGURATION	OUTPUT	LUMENS/ft.	WATTS/ft.	LUMINAIRE LUMENS	EFFICACY (LPW)
Direct - flush lens	R: regular	470	5.1	1898	93
	H: high	610	6.7	2460	91
Direct - drop lens, luminous ends	R: regular	485	5.1	1958	96
	H: high	630	6.7	2536	94



GRM30 -

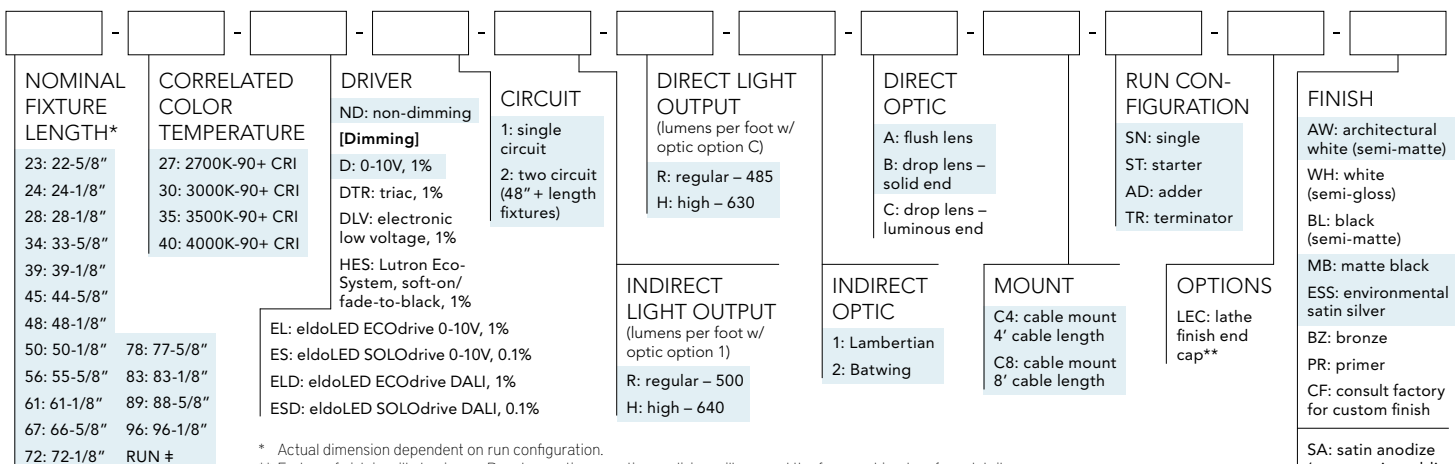



* Actual dimension dependent on run configuration.

** End cap finish is mill aluminum. Powder coating or satin anodizing will conceal the fine machined surface detail.

‡ Specify run length to the nearest 1". Factory will configure using the least quantity of fixtures as close to the desired run length as possible. Run to be confirmed with a shop drawing.

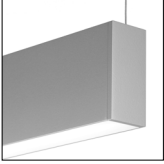
DIRECT OPTIC

ORDERING CODE	DESCRIPTION	SPECIFICATIONS
 A	FLUSH LENS	Flush frosted acrylic extrusion
 B	DROP LENS - SOLID END	1/2" H frosted acrylic extrusion with full height aluminum end cap
 C	DROP LENS - LUMINOUS END	1/2" H frosted acrylic extrusion with matching acrylic end cap

INDIRECT OPTIC

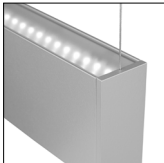
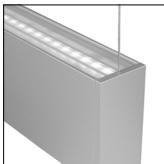
ORDERING CODE	DESCRIPTION	SPECIFICATIONS
 1	LAMBERTIAN DISTRIBUTION	Clear extruded acrylic lens for general Lambertian distribution
 2	BATWING DISTRIBUTION	Clear extruded acrylic with wide distribution optic features

MOUNTING

ORDERING CODE

DESCRIPTION

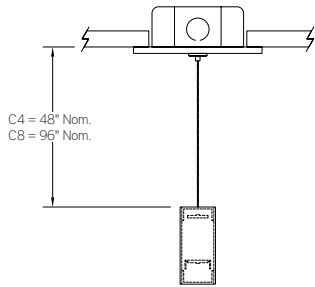

C4 and C8

CABLE MOUNT

Mounting option includes:

- \varnothing 1/32" x 48" (C4) or 96" (C8) aircraft cables
- 60" (C4) or 108" (C8) low voltage cable (in coordinating finish)
- Bracket bars
- \varnothing 5" white canopies
- Canopy mount cable grippers

OPTIONS

ORDERING CODE

DESCRIPTION

SPECIFICATIONS

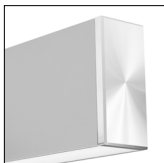

LEC

LATHE FINISH END CAP

- 1/4" thick machined aluminum end cap with chamfered edges and lathe finish face
- Finish is mill aluminum (Powder coating or satin anodizing will conceal the fine machined surface detail)

LENGTH/MOUNTING DIMENSIONS

ORDERING CODE	LENGTH A
23	22-1/4"
24	23-3/4"
28	27-3/4"
34	33-1/4"
39	38-3/4"
45	44-1/4"
48	47-3/4"
50	49-3/4"
56	55-1/4"
61	60-3/4"
67	66-1/4"
72	71-3/4"
78	77-1/4"
83	82-3/4"
89	88-1/4"
96	95-3/4"

RUN CONFIGURATION INFORMATION

ORDERING CODE	DESCRIPTION
SN	Single
ST	Starter
AD	Adder
TR	Terminator

RUN INFORMATION

Side View - Single Fixture

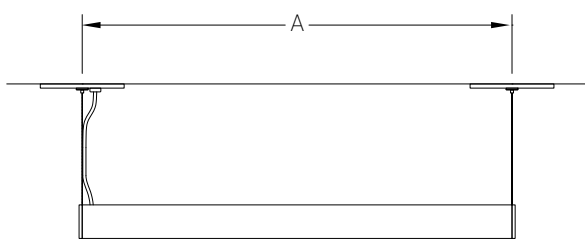

SN

Side View - Continuous Run

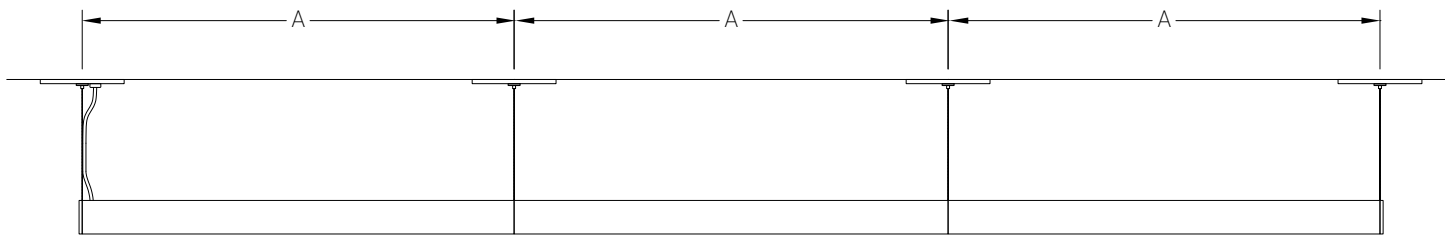

ST

AD

TR