

3" square LED luminaire with flush lens, simulated wood finish

Project: _____ Type: _____



FEATURES

The Faux series of luminaires is comprised of architectural linear profiles finished with realistic imagery that makes the fixture appear to be made of natural wood. In addition to the standard wood-look finishes, nearly limitless custom options are possible, for simulating unique materials, branding reinforcement and interior design coordination. The FAUX32 model is 3" wide by 3" tall and it fitted with a flush, frosted lens. This luminaire is available for surface, cable or wall mounting installations.

SPECIFICATIONS

Fixture constructed of an extruded aluminum housing, extruded, frosted acrylic lens and machined aluminum end caps

Model variations offered for surface, wall mount and cable suspended applications

Four standard simulated wood finishes available along with nearly limitless custom options

Finish comprised of a multi-stage application process that produces durable, high resolution imagery

Available in nominal lengths of 2'-8' single fixtures and continuous runs

Basic continuous run fixtures provided with 18 ga. wiring harness for 6 Amp maximum load (consult factory for runs requiring multiple circuits, sensor integration, etc.)

Standard integral 120-277V driver offered with 0-10V dimming or non-dim (other dimming driver options available)

Integral 120-277V emergency battery backup available for 4' or 8' nominal non-dim or 0-10V (consult factory for all other lengths/drivers)

Standard light outputs are 555, 720 and 950 lumens per foot

LEDs available in 2700K, 3000K, 3500K and 4000K, within a 3 step MacAdam ellipse, all with 90+ CRI typical

Passive infrared occupancy sensor and parabolic louver available

Life: 50,000 hours L₇₀

UL and C-UL listed for dry and damp locations

Limited five year warranty

SECTION

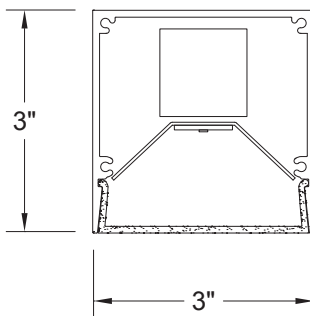

PERFORMANCE

*Note: All data reflects fixtures with 3500K LEDs

NOMINAL LENGTH	OUTPUT	LUMENS/ft.	WATTS/ft.	LUMINAIRE LUMENS	EFFICACY (LPW)
4'	L: low	555	5.6	2071	100
	R: regular	720	7.7	2690	93
	H: high	950	10.6	3535	88



FAUX32 -

NOMINAL FIXTURE LENGTH*

- 2: 22-5/8"
- 3: 33-5/8"
- 4: 44-5/8"
- 5: 55-5/8"
- 6: 66-5/8"
- 7: 77-5/8"
- 8: 88-5/8"

CORRELATED COLOR TEMPERATURE

- 27: 2700K-90+ CRI
- 30: 3000K-90+ CRI
- 35: 3500K-90+ CRI
- 40: 4000K-90+ CRI

DRIVER

ND: non-dimming

[Dimming]

D: 0-10V, 1%

HES: Lutron EcoSystem, soft-on/fade-to-black, 1%

H2: Lutron Hi-lume 2-wire forward phase, 1%, (120V ONLY)

EL: eldoLED ECOdrive 0-10V, 1%

LIGHT OUTPUT (lumens per foot)

L: low - 555

R: regular - 720

H: high - 950

CF: consult factory for custom output

MOUNT

SM: surface mount

WD: wall mount - direct

WI: wall mount - indirect

C4: cable mount 4' cable length

C8: cable mount 8' cable length

RUN CONFIGURATION

SN: single

ST: starter

AD: adder

TR: terminator

OPTIONS

ED: emergency driver (4' or 8' non-dim or 0-10V only)

S1A: occ sensor pos.1, 100%-0% ‡

S1B: occ sensor pos.1, 100%-50% ‡

S2A: occ sensor pos.2, 100%-0% ‡

S2B: occ sensor pos.2, 100%-50% ‡

S3A: occ sensor pos.3, 100%-0% ‡

S3B: occ sensor pos.3, 100%-50% ‡

FINISH

FXW: faux walnut

FXP: faux pine

FXWO: faux white oak

FXC: faux cherry

CF: consult factory for custom faux finish

* Actual dimension dependent on run configuration and sensor option
 ‡ See options section for details

MOUNTING

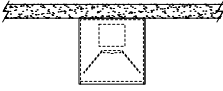
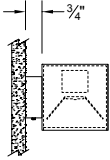
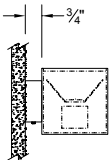
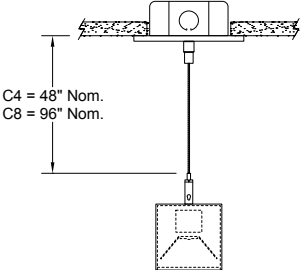
	ORDERING CODE	DESCRIPTION
	SM	<p>SURFACE MOUNT</p> <p>Use appropriate fastener through Ø3/16" holes in housing</p>
	WD	<p>WALL MOUNT – DIRECT ORIENTATION</p> <p>Mounting option includes:</p> <ul style="list-style-type: none"> 1-7/8" H x 4-1/2" W aluminum bracket projects the fixture housing 3/4" from the wall surface
	WI	<p>WALL MOUNT – INDIRECT ORIENTATION</p> <p>Mounting option includes:</p> <ul style="list-style-type: none"> 1-7/8" H x 4-1/2" W aluminum bracket projects the fixture housing 3/4" from the wall surface
	C4 and C8	<p>CABLE MOUNT</p> <p>Mounting option includes:</p> <ul style="list-style-type: none"> Ø 1/16"x 48" (C4) or 96" (C8) aircraft cables 60" (C4) or 108" (C8) power cable (in coordinating finish) Bracket bars Ø 5" white canopies Ceiling couplers Side exit cable grippers

OPTIONS

ORDERING CODE	DESCRIPTION	SPECIFICATIONS
ED	EMERGENCY LED DRIVER	<ul style="list-style-type: none"> • Universal 120-277V input voltage emergency driver delivers initial minimum power of 10W for 90 minutes • Available for 4' or 8' nominal length non-dim or 0-10V fixture only (consult factory for all other lengths/drivers) • Indicator/test switch located on the top for C4/C8 mount and on the side at an end for SM mount
	OCCUPANCY SENSOR	<ul style="list-style-type: none"> • Passive infrared occupancy sensor with hold-off daylighting adjustment (10-120 foot candles) and time delay adjustment from 30 seconds to 30 minutes • Sensor adds 4" to overall fixture length • Consult factory for custom output
S1A	Occupancy sensor – position 1, 100% – 0%	Sensor located on the lens side at an end, with 100% – 0% light output setting
S1B	Occupancy sensor – position 1, 100% – 50%	Sensor located on the lens side at an end, with 100% – 50% light output setting

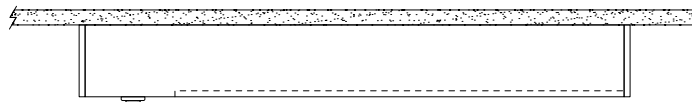

S2A	Occupancy sensor – position 2, 100% – 0%	Sensor located on the side at the right end, with 100% – 0% light output setting
S2B	Occupancy sensor – position 2, 100% – 50%	Sensor located on the side at the right end, with 100% – 50% light output setting

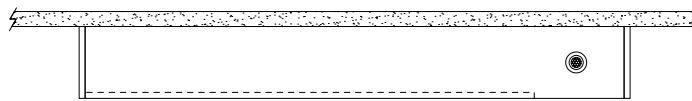



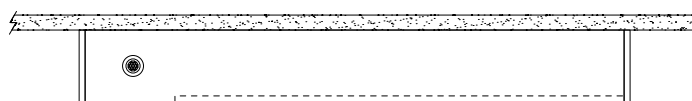

S3A	Occupancy sensor – position 3, 100% – 0%	Sensor located on the side at the left end, with 100% – 0% light output setting
S3B	Occupancy sensor – position 3, 100% – 50%	Sensor located on the side at the left end, with 100% – 50% light output setting

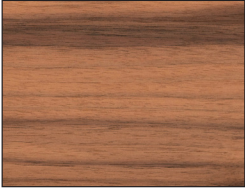
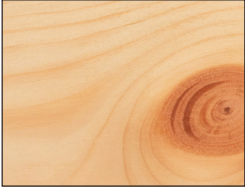
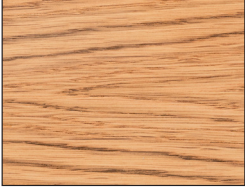

FINISH

Note: Fixture housing and end caps are treated to a multi-stage process that produces durable, high resolution imagery.

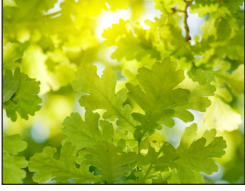
Any manner of custom imagery can be applied to Faux luminaires, from photorealistic objects, to graphic branding, to abstract representations. Images must be copyright free and meet other print standard criteria. Consult factory for specifics.

	ORDERING CODE	DESCRIPTION
	FXW	FAUX WALNUT
	FXP	FAUX PINE
	FXWO	FAUX WHITE OAK
	FXC	FAUX CHERRY
	CF	CUSTOM FAUX FINISH Consult factory for specifics
		

3" square LED luminaire with flush lens, simulated wood finish

LENGTH/MOUNTING DIMENSIONS

Note: Add 4" to dimension for any fixture using the S1, S2 or S3 occupancy sensor option

ORDERING CODE	LENGTH A	LENGTH B	LENGTH C	LENGTH D	LENGTH E
2	22-3/4"	22-1/2"	22-1/4"	16-3/4"	19-1/2"
3	33-3/4"	33-1/2"	33-1/4"	27-3/4"	30-1/2"
4	44-3/4"	44-1/2"	44-1/4"	38-3/4"	41-1/2"
5	55-3/4"	55-1/2"	55-1/4"	49-3/4"	52-1/2"
6	66-3/4"	66-1/2"	66-1/4"	60-3/4"	63-1/2"
7	77-3/4"	77-1/2"	77-1/4"	71-3/4"	74-1/2"
8	88-3/4"	88-1/2"	88-1/4"	82-3/4"	85-1/2"

RUN CONFIGURATION INFORMATION

ORDERING CODE	DESCRIPTION
SN	Single
ST	Starter
AD	Adder
TR	Terminator

RUN INFORMATION

Back Plan - Surface Mount Single Fixture

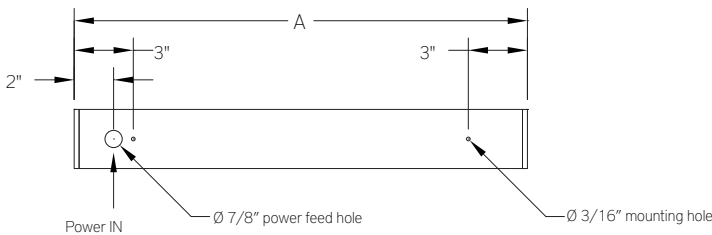

SN

Back Plan - Surface Mount Continuous Run

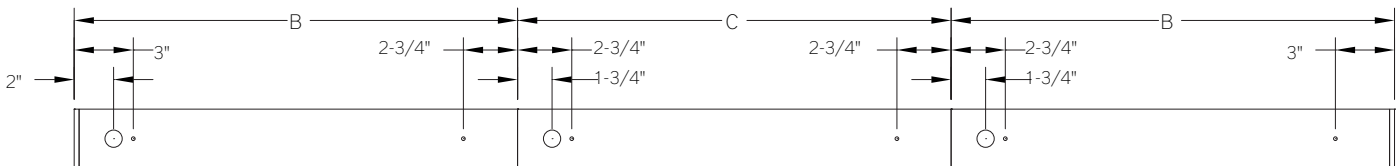

ST

AD

TR

Plan - Wall Mount Single Fixture

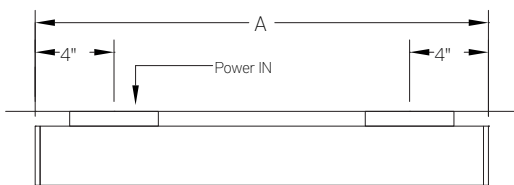

SN

Plan - Wall Mount Continuous Fixture

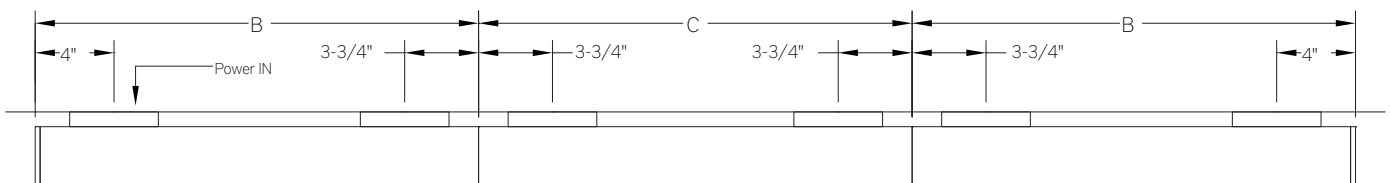

ST

AD

TR

RUN INFORMATION

Side View - Cable Mount Single Fixture

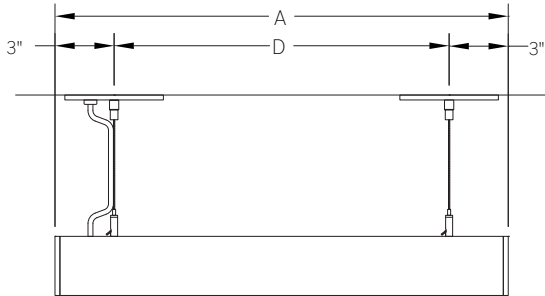

SN

Side View - Cable Mount Continuous Run

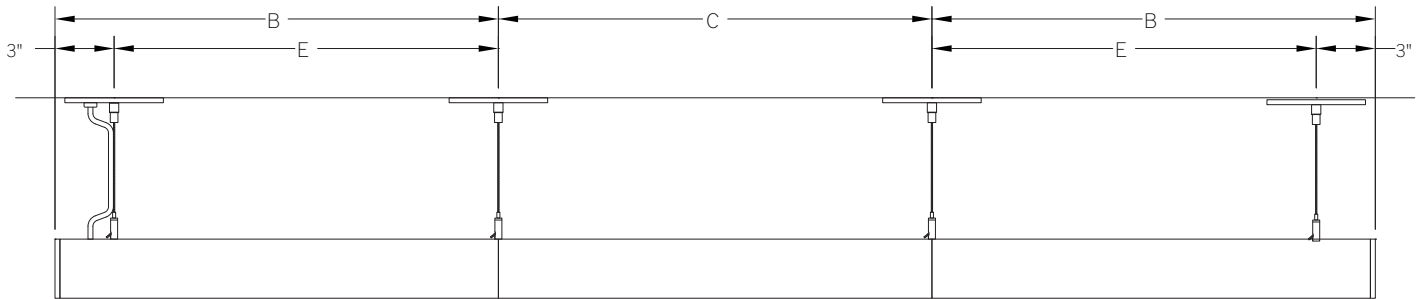

ST

AD

TR