

3" square LED luminaire with flush lens, simulated wood finish

Project: \_\_\_\_\_ Type: \_\_\_\_\_

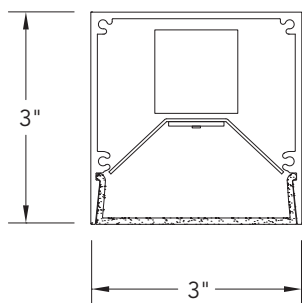

## SECTION



## PERFORMANCE

\*Note: All data reflects fixtures with 3500K LEDs

NOMINAL LENGTH	OUTPUT	LUMENS/ft.	WATTS/ft.	LUMINAIRE LUMENS	EFFICACY (LPW)
4'	L: low	555	5.6	2071	100
	R: regular	720	7.7	2690	93
	H: high	950	10.6	3535	88

## FEATURES

The Faux series of luminaires is comprised of architectural linear profiles finished with realistic imagery that makes the fixture appear to be made of natural wood. In addition to the standard wood-look finishes, nearly limitless custom options are possible, for simulating unique materials, branding reinforcement and interior design coordination. The FAUX32 model is 3" wide by 3" tall extrusion and is fitted with a flush lens and machined aluminum end caps. Surface, cable or wall mount variants are available, as well as multiple dimming drivers and light output options. The FAUX32 is Controls Capable, being offered with a variety of integrated control options

## SPECIFICATIONS

Fixture constructed of an extruded aluminum housing, flush optic and machined aluminum end caps.

Model variations offered for surface, wall mount and cable suspended applications.

Optic options include an acrylic frosted flush lens and flat blade louver.

Four standard simulated wood finishes available along with nearly limitless custom options.

Finish comprised of a multi-stage application process that produces durable, high resolution imagery.

Available in nominal lengths of 2'-8' single fixtures and continuous runs.

Basic continuous run fixtures provided with 18 ga. wiring harness for 6 Amp maximum load (consult factory for runs requiring multiple circuits, sensor integration, etc.).

Standard integral 120-277V driver offered with 0-10V dimming or non-dim (other dimming driver options available).

Integral 120-277V emergency battery backup available for 4' or 8' nominal non-dim or 0-10V (consult factory for all other lengths/drivers).

Standard light outputs are 555, 720 and 950 lumens per foot.

LEDs available in 2700K, 3000K, 3500K and 4000K, within a 3 step MacAdam ellipse, all with 90+ CRI typical.

Bartco Lighting Controls Capable fixture available with integrated controls from a variety of suppliers.

Life: 50,000 hours L<sub>70</sub>

UL and C-UL listed for dry and damp locations

Limited five year warranty



## FAUX32 -

NOMINAL FIXTURE LENGTH*	CORRELATED COLOR TEMPERATURE	DRIVER	LIGHT OUTPUT (lumens per foot)	MOUNT	OPTIONS	FINISH
2: 22-3/4"	27: 2700K-90+ CRI	ND: non-dimming	L: low – 555	SM: surface mount	ED: emergency driver (4' or 8' nom. non-dim or 0-10V only)	FXW: faux walnut
3: 33-3/4"	30: 3000K-90+ CRI	D: 0-10V, 1%	R: regular – 720	WD: wall mount – direct	FS-205, 100%-0% ‡	FXP: faux pine
4: 44-3/4"	35: 3500K-90+ CRI	DTR: triac, 1%, (120V ONLY)	H: high – 950	Wl: wall mount – indirect	WS1A: Wattstopper FS-205, 100%-0% ‡	FXWO: faux white oak
5: 55-3/4"	40: 4000K-90+ CRI	DLV: electronic low voltage, 1%, (120V ONLY)	CF: consult factory for custom output	C4: cable mount 4' cable length	WS1B: Wattstopper FS-205, 100%-50% ‡	FXC: faux cherry
6: 66-3/4"		HES: Lutron EcoSystem, soft-on/fade-to-black, 1%		C8: cable mount 8' cable length	EN1: Enlighted FS-D22 ‡	CF: consult factory for custom faux finish
7: 77-3/4"		EL: eldoLED ECOdrive 0-10V, 1%			ES4: Philips EasySense SNS211 MC ‡	
8: 88-3/4"		ES: eldoLED SOLOdrive 0-10V, 0.1%		<b>OPTIC</b>	CA1: Casambi CBU-A2D ‡	
		ELD: eldoLED ECOdrive DALI, 1%		L: louver	NL1: nLight RES7 ‡	
		ESD: eldoLED SOLOdrive DALI, 0.1%			NL2: nLight RIO ‡	
					LA1: Lutron Athena A-WN-D01-RF-WH ‡	
					LA2: Lutron Athena A-WN-D01-OCC-WH ‡	
				<b>RUN CONFIGURATION</b>		
				SN: single		
				ST: starter		
				AD: adder		
				TR: terminator		

\* Actual dimension dependent on run configuration.

‡ See Integrated Controls section for driver compatibility information.

## OPTIC

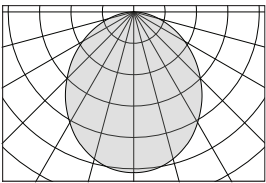
	ORDERING CODE	DESCRIPTION	SPECIFICATIONS
	1	LAMBERTIAN DISTRIBUTION	Frosted extruded acrylic lens for general Lambertian distribution.
	L	LOUVER	3" W Flat blade louver with 5/8" blades at 7/8" spacing, formed from sheet steel.  Finish is Environmental Satin Silver (consult factory for alternate finishes).  Supplied with light diffusion film.

## MOUNTING

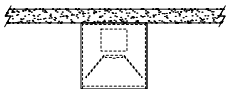
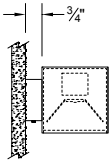
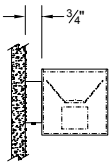
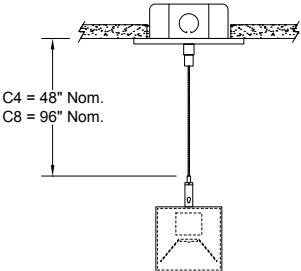
	ORDERING CODE	DESCRIPTION
	SM	SURFACE MOUNT  Use appropriate fastener through Ø3/16" holes in housing
	WD	WALL MOUNT – DIRECT ORIENTATION  • 1-7/8" H x 4-1/2" W sheet aluminum bracket projects the fixture housing 3/4" from the wall surface.
	WI	WALL MOUNT – INDIRECT ORIENTATION  • 1-7/8" H x 4-1/2" W sheet aluminum bracket projects the fixture housing 3/4" from the wall surface.
	C4 and C8	CABLE MOUNT  Mounting option includes: <ul style="list-style-type: none"> <li>• Ø 1/16" x 48" (C4) or 96" (C8) aircraft cables</li> <li>• 60" (C4) or 108" (C8) power cable (in coordinating finish)</li> <li>• Bracket bars</li> <li>• Ø 5" white canopies</li> <li>• Ceiling couplers</li> <li>• Side exit cable grippers</li> </ul>

## OPTIONS

ORDERING CODE	DESCRIPTION	SPECIFICATIONS
ED	EMERGENCY LED DRIVER	<ul style="list-style-type: none"><li>• Universal 120-277V input voltage emergency driver delivers initial minimum power of 10W for 90 minutes.</li><li>• Available for 4' or 8' nominal length non-dim or 0-10V fixture only (consult factory for all other lengths/drivers).</li><li>• Indicator/test switch located on the top for C4/C8 mount and on the side at an end for SM mount.</li></ul>

OPTIONS - INTEGRATED CONTROLS

Note: Control option takes up 4" of the overall lens length. Controls are mounted to flush filler piece. Filler piece matches fixture finish.







	ORDERING CODE	LIGHT OUTPUT SETTING	MODEL	CONTROL PROTOCOL	FUNCTIONS	COMPATIBLE DRIVERS
<b>legrand</b> WATTSTOPPER®	WS1A	100% – 0% <sup>1</sup>	FS-205	N/A	PIR occupancy and light level sensor.	For use with on/off or 0-10V dimming drivers only.
	WS1B	100% – 50% <sup>1</sup>				
<b>Enlighted</b>	EN1	Set during commissioning	FS-D22	Bluetooth Wireless	PIR occupancy, ambient light sensing, daylight harvesting, and environment monitoring for use within an Enlighted control network.	Provided with Advance sensor ready series 0-10V dimming drivers.
<b>PHILIPS</b> EasySense	ES4	Set during commissioning	SNS211 MC	Bluetooth Wireless	Occupancy, daylight harvesting and task tuning sensor with advance grouping, for use within a MasterConnect network.	Provided with Advance sensor ready series 0-10V dimming drivers.
<b>CASAMBI</b>	CA1	Set during commissioning	CBU-A2D	Bluetooth Wireless	0-10V/DALI driver controller, for use within a Casambi ecosystem.	For use with 0-10V or DALI drivers. Consult factory for details.
<b>nLIGHT</b>	NL1	Set during commissioning	RES7 <sup>2</sup>	Radio Wireless	Dimming, PIR occupancy detection and daylight harvesting, for use within an nLight AIR network.	Provided with Advance sensor ready series or eldoLED 0-10V drivers.
	NL2		RIO <sup>2</sup>		Dimming, for use within an nLight AIR network.	
<b>LUTRON</b> ®	LA1	Set during commissioning	A-WN-D01-RF-WH	Radio Wireless	Dimming only for use with an Athena control system.	Provided with Advance sensor ready series or eldoLED 0-10V or eldoLED DALI-2 drivers.
	LA2		A-WN-D01-OCC-WH		Dimming, PIR occupancy and daylight sensor for use with an Athena control system.	

1. Consult factory for custom light output setting.  
2. Consult your Acuity representative for application-specific model number.

FINISH

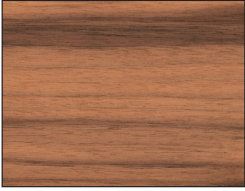
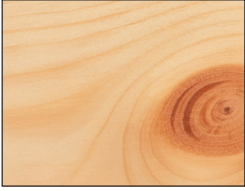
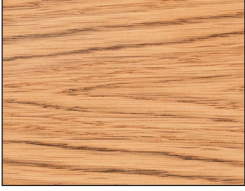
Note: Fixture housing and end caps are treated to a multi-stage process that produces durable, high resolution imagery.

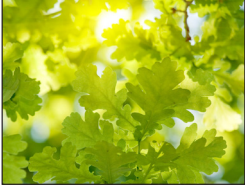
Any manner of custom imagery can be applied to Faux luminaires, from photorealistic objects, to graphic branding, to abstract representations. Images must be copywrite free and meet other print standard criteria. Consult factory for specifics.

	ORDERING CODE	DESCRIPTION
	FXW	FAUX WALNUT
	FXP	FAUX PINE
	FXWO	FAUX WHITE OAK
	FXC	FAUX CHERRY
	CF	CUSTOM FAUX FINISH Consult factory for specifics.
		

## LENGTH / MOUNTING DIMENSIONS

ORDERING CODE	LENGTH A	LENGTH B	LENGTH C	LENGTH D	LENGTH E
2	22-3/4"	22-1/2"	22-1/4"	16-3/4"	19-1/2"
3	33-3/4"	33-1/2"	33-1/4"	27-3/4"	30-1/2"
4	44-3/4"	44-1/2"	44-1/4"	38-3/4"	41-1/2"
5	55-3/4"	55-1/2"	55-1/4"	49-3/4"	52-1/2"
6	66-3/4"	66-1/2"	66-1/4"	60-3/4"	63-1/2"
7	77-3/4"	77-1/2"	77-1/4"	71-3/4"	74-1/2"
8	88-3/4"	88-1/2"	88-1/4"	82-3/4"	85-1/2"

## RUN CONFIGURATION INFORMATION

ORDERING CODE	DESCRIPTION
SN	Single
ST	Starter
AD	Adder
TR	Terminator

## RUN INFORMATION

Back Plan - Surface Mount Single Fixture

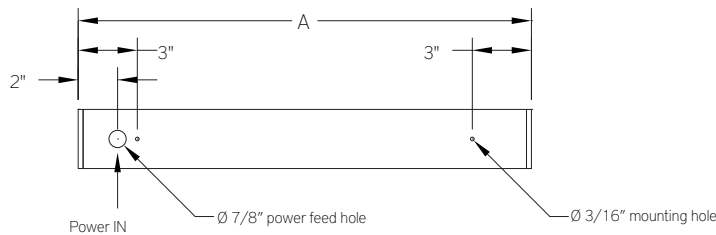

SN

Back Plan - Surface Mount Continuous Run

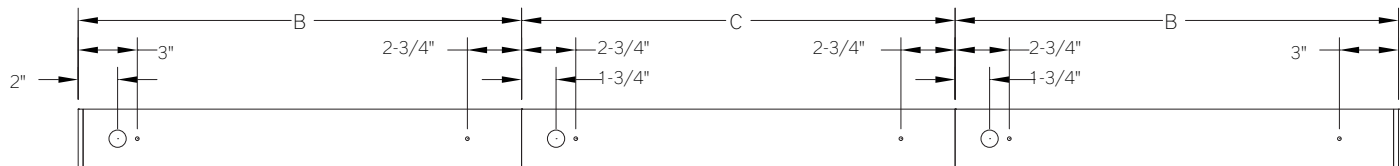

ST

AD

TR

Plan - Wall Mount Single Fixture

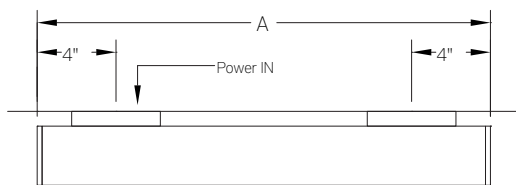

SN

Plan - Wall Mount Continuous Fixture

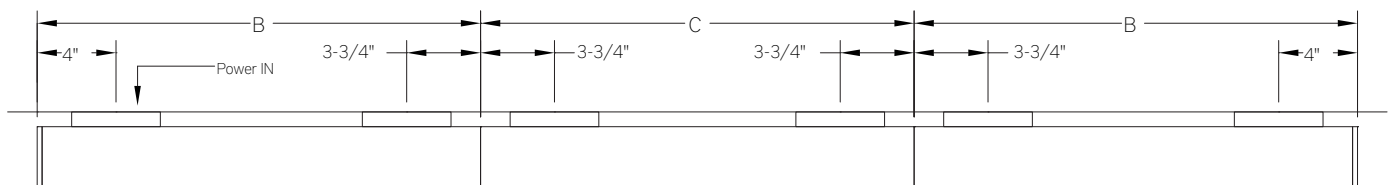

ST

AD

TR

## RUN INFORMATION

Side View - Cable Mount Single Fixture

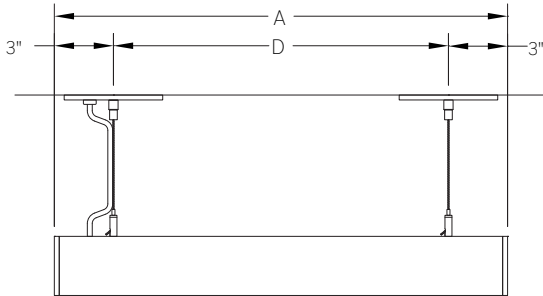

SN

Side View - Cable Mount Continuous Run

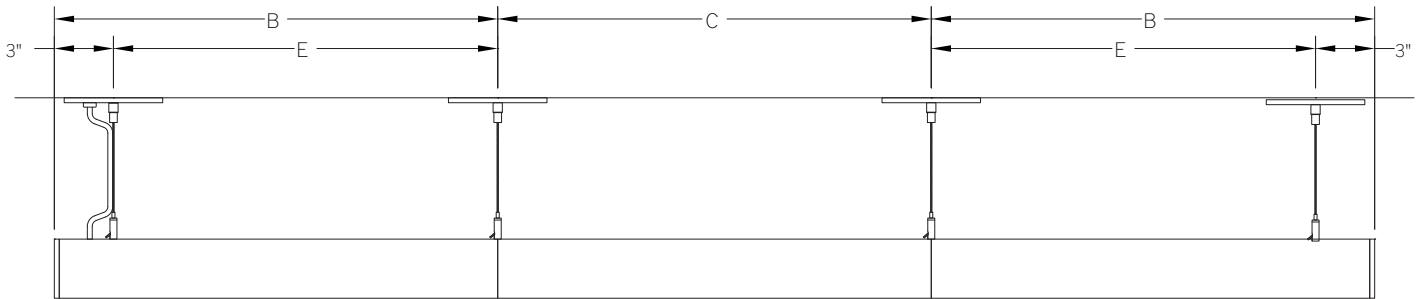

ST

AD

TR