

2" wide direct/indirect LED luminaire with simulated wood finish

Project: _____ Type: _____



FEATURES

The Faux series of luminaires is comprised of architectural linear profiles finished with realistic imagery that makes the fixture appear to be made of natural wood. In addition to the standard wood-look finishes, nearly limitless custom options are possible, for simulating unique materials, branding reinforcement and interior design coordination. The FAUX31 direct/indirect model is 2" wide by 3-1/2" tall and is offered with multiple optic options for cable or wall mount installations.

SPECIFICATIONS

Fixture constructed of extruded aluminum, frosted extruded acrylic lenses and machined aluminum end caps

Model variations offered for wall mount and cable suspended applications

Four standard simulated wood finishes available along with nearly limitless custom options

Finish comprised of a multi-stage application process that produces durable, high resolution imagery

Available in nominal lengths of 2'-8' single fixtures and continuous runs

Basic continuous run fixtures provided with 18 ga. wiring harness for 6 Amp maximum load (consult factory for runs requiring multiple circuits, sensor integration, etc.)

Standard integral 120-277V driver offered with 0-10V dimming or non-dim (other dimming driver options available)

Integral 120-277V emergency battery backup available for 6' or 8' nominal, single circuit non-dim or 0-10V (consult factory for all other lengths/drivers)

Standard outputs are 500 or 650 lumens per foot direct and 465 or 600 lumens per foot indirect

LEDs available in 2700K, 3000K, 3500K and 4000K, within a 3 step MacAdam ellipse, all with 90+ CRI typical

Life: 50,000 hours L₇₀

UL and C-UL listed for dry and damp locations

Limited five year warranty



SECTION

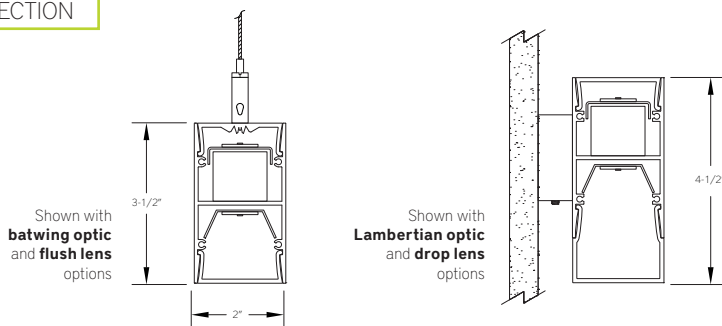

PERFORMANCE

Note: All data reflects fixtures with 3500K LEDs

NOMINAL LENGTH	OPTIC CONFIGURATION	OUTPUT	LUMENS/ft.	WATTS/ft.	LUMINAIRE LUMENS	EFFICACY (LPW)
4'	Indirect – Lambertian	L: low	465	5	1738	93
		R: regular	600	7.2	2257	84
	Indirect – batwing	L: low	570	5.7	2112	100
		R: regular	740	7.9	2743	94
	Direct – flush lens	L: low	470	5	1755	94
		R: regular	610	7.2	2279	85
	Direct – drop lens, solid end	L: low	500	5	1850	99
		R: regular	650	7.2	2402	90

FAUX31 –

NOMINAL FIXTURE LENGTH* 2: 22-5/8" 3: 33-5/8" 4: 44-5/8" 5: 55-5/8" 6: 66-5/8" 7: 77-5/8" 8: 88-5/8"	DRIVER ND: non-dimming [Dimming] D: 0-10V, 1% HES: Lutron EcoSystem, soft-on/fade-to-black, 1% H2: Lutron Hi-lume 2-wire forward phase, 1%, (120V ONLY) EL: eldoLED ECOdrive 0-10V, 1%	INDIRECT LIGHT OUTPUT (lumens per foot w/optic option 1) L: low – 465 R: regular – 600 CF: consult factory for custom output	INDIRECT OPTIC 1: general Lambertian distribution 2: batwing distribution	MOUNT C4: cable mount 4' cable length C8: cable mount 8' cable length WM: wall mount CF: consult factory for custom mounting	OPTIONS ED: emergency driver (6' or 8' SINGLE CIRCUIT, non-dim or 0-10V only)	FINISH FXW: faux walnut FXP: faux pine FXWO: faux white oak FXC: faux cherry CF: consult factory for custom faux finish
CORRELATED COLOR TEMPERATURE 27: 2700K-90+ CRI 30: 3000K-90+ CRI 35: 3500K-90+ CRI 40: 4000K-90+ CRI	CIRCUIT 1: single circuit 2: two circuit (4' nom. length and longer)	DIRECT LIGHT OUTPUT (lumens per foot w/optic option B) L: low – 500 R: regular – 650 CF: consult factory for custom output	DIRECT OPTIC A: flush lens B: drop lens – solid end C: drop lens – luminous end D: louver (4' and 8' only)	RUN CONFIGURATION SN: single ST: starter AD: adder TR: terminator		

* Actual dimension dependent on run configuration

INDIRECT OPTIC OPTION

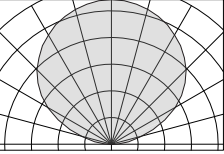
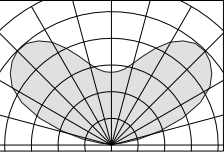
ORDERING CODE	DESCRIPTION	SPECIFICATIONS
	1 LAMBERTIAN DISTRIBUTION	Frosted extruded acrylic lens for general Lambertian distribution
	2 BATWING DISTRIBUTION	Clear extruded acrylic with wide distribution optic features

DIRECT OPTIC OPTION

ORDERING CODE	DESCRIPTION	SPECIFICATIONS
	A FLUSH LENS	Flush frosted acrylic extrusion
	B DROP LENS - SOLID END	1" H frosted acrylic extrusion with full height aluminum end cap
	C DROP LENS - LUMINOUS END	1" H frosted acrylic extrusion with matching acrylic end cap
	D LOUVER	Parabolic louver with 5/8" blades at 1" spacing, formed from diffuse, high reflectance aluminum and supplied with light diffusion film. Available for 4' and 8' nominal length fixtures.

MOUNTING

	ORDERING CODE	DESCRIPTION
	WM	<p>WALL MOUNT</p> <p>Mounting option includes:</p> <ul style="list-style-type: none"> 1-7/8"H x 4-1/2"W aluminum bracket projects the fixture housing 3/4" from the wall surface
	C4 and C8	<p>CABLE MOUNT</p> <p>Mounting option includes:</p> <ul style="list-style-type: none"> Ø 1/16"x 48" (C4) or 96" (C8) aircraft cables 60" (C4) or 108" (C8) power cable in coordinating finish Bracket bars Ø 5" white canopies Ceiling couplers Side exit cable grippers <p>NOTE: WHEN DUAL CIRCUIT OPTION IS USED, TWO POWER CABLES ARE REQUIRED</p>





OPTIONS

ORDERING CODE	DESCRIPTION	SPECIFICATIONS
ED	EMERGENCY LED DRIVER	<ul style="list-style-type: none"> Universal 120-277V input voltage emergency driver delivers initial minimum power of 10W for 90 minutes Available for SINGLE CIRCUIT 6' or 8' nominal length non-dim or 0-10V fixture and direct light source only (consult factory for all other lengths/drivers)

FINISH

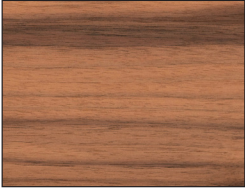
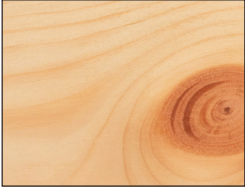
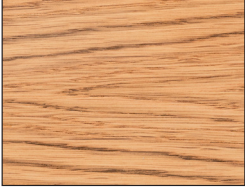
Note: Fixture housing and end caps are treated to a multi-stage process that produces durable, high resolution imagery.

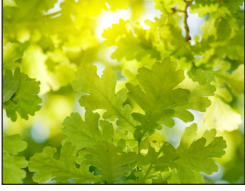
Any manner of custom imagery can be applied to Faux luminaires, from photorealistic objects, to graphic branding, to abstract representations. Images must be copyright free and meet other print standard criteria. Consult factory for specifics.

	ORDERING CODE	DESCRIPTION
	FXW	FAUX WALNUT
	FXP	FAUX PINE
	FXWO	FAUX WHITE OAK
	FXC	FAUX CHERRY
 	CF	CUSTOM FAUX FINISH Consult factory for specifics

LENGTH/MOUNTING DIMENSIONS

ORDERING CODE	LENGTH A	LENGTH B	LENGTH C	LENGTH D	LENGTH E
2	22-5/8"	22-3/8"	22-1/8"	21-1/8"	21-5/8"
3	33-5/8"	33-3/8"	33-1/8"	32-1/8"	32-5/8"
4	44-5/8"	44-3/8"	44-1/8"	43-1/8"	43-5/8"
5	55-5/8"	55-3/8"	55-1/8"	54-1/8"	54-5/8"
6	66-5/8"	66-3/8"	66-1/8"	65-1/8"	65-5/8"
7	77-5/8"	77-3/8"	77-1/8"	76-1/8"	76-5/8"
8	88-5/8"	88-3/8"	88-1/8"	87-1/8"	87-5/8"

RUN CONFIGURATION INFORMATION

ORDERING CODE	DESCRIPTION
SN	Single
ST	Starter
AD	Adder
TR	Terminator

RUN INFORMATION

Plan - Wall Mount Single Fixture

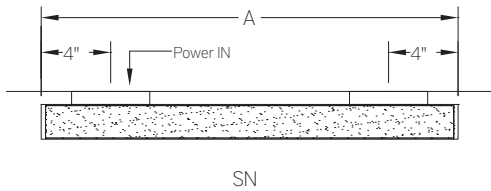

Plan - Wall Mount Continuous Run

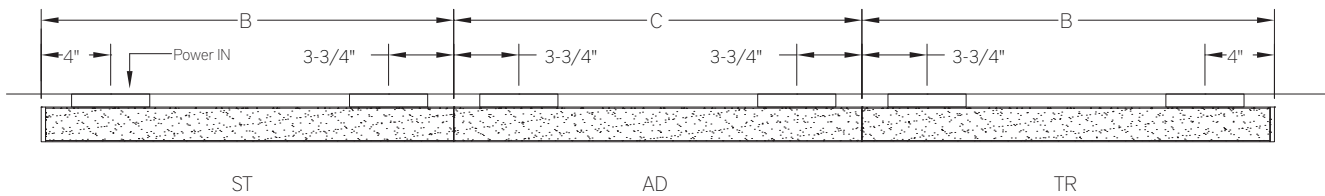

Side View - Cable Suspended Single Fixture

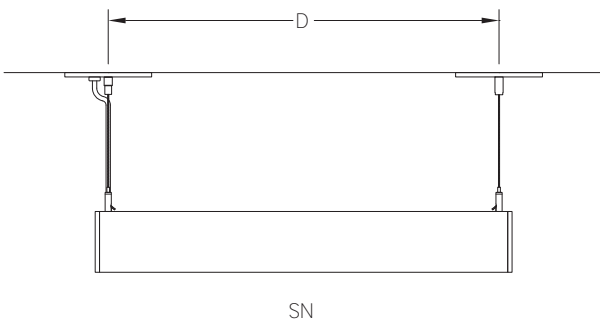

Side View - Cable Suspended Continuous Run

