

2" wide aperture LED luminaire with flush lens, wood or steel cladding

Project: _____ Type: _____

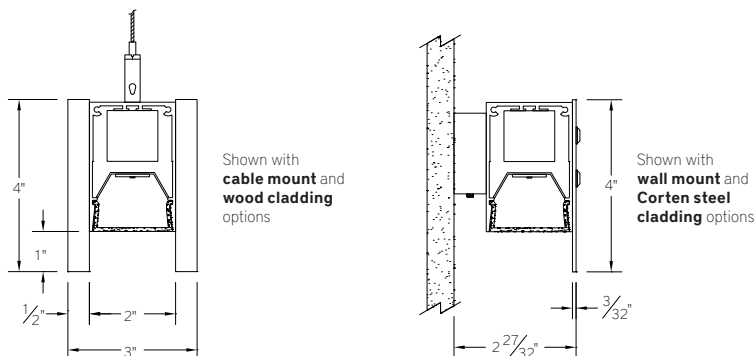

SECTION



PERFORMANCE

Note: All data reflects fixtures with 3500K LEDs

NOMINAL LENGTH	OUTPUT	LUMENS/ft.	WATTS/ft.	LUMINAIRE LUMENS	EFFICACY (LPW)
4'	L: low	315	4.5	1795	69
	R: regular	405	7.4	1573	55

FEATURES

The REAL80 is a linear directional LED luminaire for general lighting applications. The 2" wide by 3" tall aluminum extruded housing is clad with 1/2" thick wood planks or heavy gauge Corten steel. The furniture grade wood options are available in several standard varieties, with hand applied finishes, while the Corten steel is clear coated. The REAL80 is available for cable or wall mounting and offered with a variety of dimming driver and light color options for added versatility.

SPECIFICATIONS

Fixture constructed of an extruded aluminum housing, extruded, frosted acrylic lens, machined aluminum end caps and wood or steel cladding

Model variations offered for cable suspended and wall mount applications

Standard housing and end cap finishes as shown below.

Wood side cladding is 1/2" thick, furniture grade, in solid walnut, European beech, mahogany, white oak and bamboo ply or nine-ply Baltic birch with maple face

Solid wood planks and bamboo ply are hand finished in five to seven coats of clear shellac and sealed with clear liquid wax for a natural look and easy cleaning

Baltic birch planks are available with a clear shellac finish or water-based stain with clear sealer

Corten steel side cladding is 14 gauge with matte clear powder coat finish and includes button head fasteners in black finish

Optional decorative industrial hardware with black finish available for wood cladding

Fixtures available in nominal lengths of 2'-8'

Standard integral 120-277V driver offered with 0-10V dimming or non-dim (other dimming driver options available)

Integral 120-277V emergency battery backup available for 6' or 8' nominal, single circuit fixtures with non-dim or 0-10V dimming (consult factory for all other lengths/drivers)

Standard light outputs are 315 and 405 lumens per foot

LEDs available in 2700K, 3000K, 3500K and 4000K, within a 3 step MacAdam ellipse, all with 90+ CRI typical

Parabolic louver option available

Life: 50,000 hours L₇₀

Limited five year warranty

UL and C-UL listed for dry locations



REAL80 -





* Applies to solid wood and plywood cladding.

O. A. FIXTURE LENGTH	CORRELATED COLOR TEMPERATURE	DRIVER	LIGHT OUTPUT (lumens per foot)	MOUNT	OPTIONS	HOUSING/END CAP FINISH	CLADDING FINISH
2: 24-5/8"	27: 2700K-90+ CRI	ND: non-dimming	L: low - 315	WD: wall mount - direct	ED: emergency driver (4' or 8' non-dim or 0-10V only)	AW: architectural white (semi-matte)	WN: walnut
3: 35-5/8"	30: 3000K-90+ CRI	D: 0-10V, 1%	R: regular - 405	WI: wall mount - indirect	L: louver (4' and 8' ONLY)	WH: white (semi-gloss)	EB: european beech
4: 46-5/8"	35: 3500K-90+ CRI	DTR: triac, 1%	CF: consult factory for custom output	C4: cable mount 4' cable length	DH1: deco. hardware - flanged button head *	BL: black (semi-matte)	MH: mahogany
5: 57-5/8"	40: 4000K-90+ CRI	DLV: electronic low voltage, 1%		C8: cable mount 8' cable length	DH2: deco. hardware - flanged hex head *	MB: matte black	WO: white oak
6: 68-5/8"		HES: Lutron Eco-System, soft-on fade-to-black, 1%				ESS: environmental satin silver	BB: bamboo
7: 79-5/8"		EL: eldoLED ECOdrive 0-10V, 1%				BZ: bronze	P01: Baltic birch - maple
8: 90-5/8"		ES: eldoLED SOLOdrive 0-10V, 0.1%				PR: primer	P02: Baltic birch - red
		ELD: eldoLED ECOdrive DALI, 1%					P03: Baltic birch - orange
		ESD: eldoLED SOLOdrive DALI, 0.1%					P04: Baltic birch - green
							P05: Baltic birch - blue
							CS: Corten Steel
							CF: consult factory for custom finish

RUN CONFIGURATION

SN: single

OPTIONS

ORDERING CODE	DESCRIPTION	SPECIFICATIONS
	<p>ED EMERGENCY LED DRIVER</p>	<ul style="list-style-type: none"> • Universal 120-277V input voltage emergency driver delivers initial minimum power of 10W for 90 minutes • Available for SINGLE CIRCUIT, 6' or 8' nominal length non-dim or 0-10V fixture only (consult factory for all other lengths/drivers) • Provided with combination test switch/indicator light mounted to wall plate for remote installation
	<p>L LOUVER</p>	<p>Parabolic louver with 5/8" blades at 1" spacing, formed from diffuse, high reflectance aluminum and supplied with light diffusion film</p> <p>Available for 4' and 8' nominal length fixtures</p>
	<p>DH1 DECORATIVE HARDWARE – FLANGED BUTTON HEAD</p>	<p>Flanged button head decorative industrial hardware in black oxide finish</p> <p>For solid wood and plywood cladding</p>
	<p>DH2 DECORATIVE HARDWARE – FLANGED HEX HEAD</p>	<p>Flanged hex head decorative industrial hardware in black oxide finish</p> <p>For solid wood and plywood cladding</p>

NOTE: WOOD SIDES NOT SHOWN.









MOUNTING

	ORDERING CODE	DESCRIPTION
	WD	<p>WALL MOUNT – DIRECT ORIENTATION</p> <p>Mounting option includes:</p> <ul style="list-style-type: none"> • 1-7/8" H x 2-1/2" W aluminum bracket projects the fixture housing 3/4" from the wall surface
	WI	<p>WALL MOUNT – INDIRECT ORIENTATION</p> <p>Mounting option includes:</p> <ul style="list-style-type: none"> • 1-7/8" H x 2-1/2" W aluminum bracket projects the fixture housing 3/4" from the wall surface
	C4 and C8	<p>CABLE MOUNT</p> <p>Mounting option includes:</p> <ul style="list-style-type: none"> • Ø 1/16" x 48" (C4) or 96" (C8) aircraft cables • 60" (C4) or 108" (C8) power cable (in coordinating finish) • Bracket bars • Ø 5" white canopies • Ceiling couplers • Side exit cable grippers

2" wide aperture LED luminaire with flush lens, wood or steel cladding

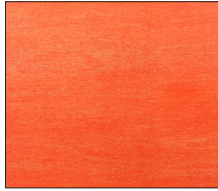
FINISH

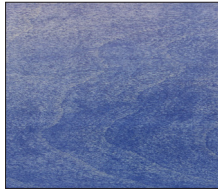
- All wood planks are hand selected from the top grades available, for minimal defects, with high consistency in grain, color and contrast. Being a natural material, some variances in these qualities are to be expected.
- Solid woods, bamboo ply and Baltic birch ply with natural maple are finished in five to seven coats of hand applied natural shellac, followed by a liquid wax sealer for easy cleaning.
- Stained Baltic birch plywood options are hand finished in multiple coats of semi-transparent stain, followed by a clear sealer.
- Corten steel cladding is finished in matte clear powder coat and includes button head fasteners in black finish. Due to the oxidizing nature of the material, variations in surface finish patina are to be expected.

	ORDERING CODE	DESCRIPTION		ORDERING CODE	DESCRIPTION
	WN	SOLID WALNUT		P01	BALTIC BIRCH PLY - NATURAL MAPLE
	EB	SOLID EUROPEAN BEECH		P02	BALTIC BIRCH PLY - RED STAINED MAPLE
	MH	SOLID MAHOGANY		P03	BALTIC BIRCH PLY - ORANGE STAINED MAPLE
	WO	SOLID WHITE OAK		P04	BALTIC BIRCH PLY - GREEN STAINED MAPLE
	BB	BAMBOO PLY		P05	BALTIC BIRCH PLY - BLUE STAINED MAPLE
	CS	CORTEN STEEL			

LENGTH/MOUNTING DIMENSIONS

ORDERING CODE	LENGTH A	LENGTH B
2	24-5/8"	16-5/8"
3	35-5/8"	27-5/8"
4	46-5/8"	38-5/8"
5	57-5/8"	49-5/8"
6	68-5/8"	60-5/8"
7	79-5/8"	71-5/8"
8	90-5/8"	82-5/8"

RUN CONFIGURATION INFORMATION

ORDERING CODE	DESCRIPTION
SN	Single

RUN INFORMATION

Back Plan - Surface Mount Single Fixture Option

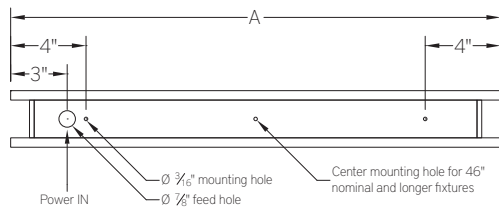

SN

Plan - Wall Mount Single Fixture Option

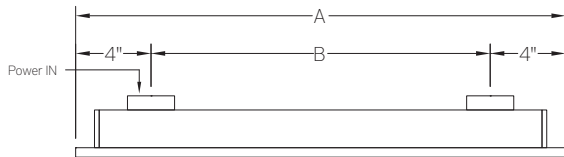

SN

Side View - Cable Mount Single Fixture Option

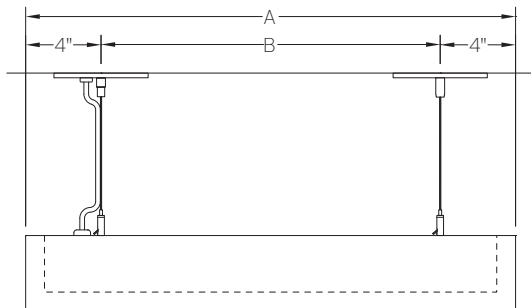

SN