

BSS214 | **bodhi**

3" square LED luminaire with flush lens

Project: _____ Type: _____



FEATURES

The BSS214 is a linear LED luminaire for general lighting applications. The 3" square extrusion, fitted with a flush, frosted lens and machined aluminum end caps. Surface, cable or wall mounting options are available, as well as a variety of dimming drivers and light outputs, to maximize the versatility of this clean design luminaire.

SPECIFICATIONS

Fixture constructed of an extruded aluminum housing, extruded, frosted acrylic lens and machined aluminum end caps

Model variations offered for surface, wall mount and cable suspended applications

Standard finishes as shown below

Available in nominal lengths of 2'-8' single fixtures and continuous runs

Basic continuous run fixtures provided with 18 ga. wiring harness for 6 Amp maximum load (consult factory for runs requiring multiple circuits, sensor integration, etc.)

Standard integral 120-277V driver offered with 0-10V dimming or non-dim (other dimming driver options available)

Integral 120-277V emergency battery backup available for 4' or 8' nominal non-dim or 0-10V (consult factory for all other lengths/drivers)

Passive infrared occupancy sensor available

Standard outputs are 555, 720, and 950 lumens per foot

LEDs available in 2700K, 3000K, 3500K and 4000K, within a 3 step MacAdam ellipse, all with 90+ CRI typical

Life: 50,000 hours L₇₀

Limited five year warranty

UL and C-UL listed for dry and damp locations

SECTION

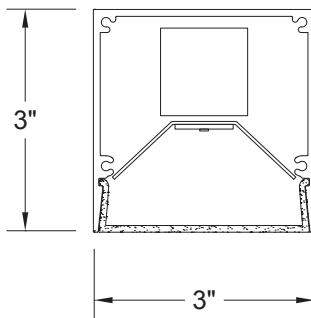

PERFORMANCE

NOMINAL LENGTH	OUTPUT	LUMENS/ft.	WATTS/ft.	LUMINAIRE LUMENS	EFFICACY (LPW)
4'	L: low	555	5.6	2071	100
	R: regular	720	7.7	2690	93
	H: high	950	10.6	3535	88

Note: All data reflects fixture with 3500K LEDs



BSS214 -

NOMINAL FIXTURE LENGTH*

- 2: 22-3/4"
- 3: 33-3/4"
- 4: 44-3/4"
- 5: 55-3/4"
- 6: 66-3/4"
- 7: 77-3/4"
- 8: 88-3/4"

CORRELATED COLOR TEMPERATURE

- 27: 2700K-90+ CRI
- 30: 3000K-90+ CRI
- 35: 3500K-90+ CRI
- 40: 4000K-90+ CRI

DRIVER

- ND: non-dimming
- [Dimming]**
- D: 0-10V, 1%
- DTR: triac, 1%
- DLV: electronic low voltage, 1%
- HES: Lutron EcoSystem, soft-on/fade-to-black, 1%
- EL: eldoLED ECOdrive, 0-10V, 1%
- ES: eldoLED SOLOdrive 0-10V, 0.1%
- ELD: eldoLED ECOdrive DALI, 1%
- ESD: eldoLED SOLOdrive DALI, 0.1%

LIGHT OUTPUT (lumens per foot)

- L: low – 555
- R: regular – 720
- H: high – 950
- CF: consult factory for custom output

MOUNT

- SM: surface mount
- WD: wall mount – direct
- WI: wall mount – indirect
- C4: cable mount 4' cable length
- C8: cable mount 8' cable length

RUN CONFIGURATION

- SN: single
- ST: starter
- AD: adder
- TR: terminator

OPTIONS

- ED: emergency driver (4' or 8' non-dim or 0-10V only)
- S1A: occ sensor pos.1, 100%–0% ‡
- S1B: occ sensor pos.1, 100%–50% ‡
- S2A: occ sensor pos.2, 100%–0% ‡
- S2B: occ sensor pos.2, 100%–50% ‡
- S3A: occ sensor pos.3, 100%–0% ‡
- S3B: occ sensor pos.3, 100%–50% ‡

FINISH

- AW: architectural white (semi-matte)
- WH: white (semi-gloss)
- BL: black (semi-matte)
- MB: matte black
- ESS: environmental satin silver
- BZ: bronze
- PR: primer
- CF: consult factory for custom finish
- SA: satin anodize (may require additional lead time)

* Actual dimension dependent on run configuration and sensor option.
‡ See options section for details.

BSS214 | **bodhi**

3" square LED luminaire with flush lens

MOUNTING

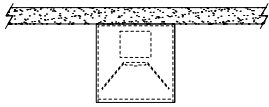
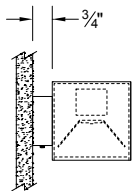
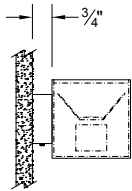
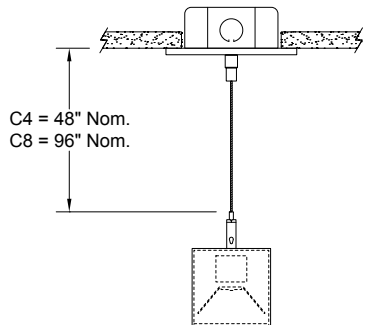
	ORDERING CODE	DESCRIPTION
	SM	<p>SURFACE MOUNT</p> <p>Use appropriate fastener through $\varnothing 3/16"$ holes in housing</p>
	WD	<p>WALL MOUNT – DIRECT ORIENTATION</p> <p>Mounting option includes:</p> <ul style="list-style-type: none"> • 1-7/8" H x 4-1/2" W aluminum bracket projects the fixture housing 3/4:" from the wall surface
	WI	<p>WALL MOUNT – INDIRECT ORIENTATION</p> <p>Mounting option includes:</p> <ul style="list-style-type: none"> • 1-7/8" H x 4-1/2" W aluminum bracket projects the fixture housing 3/4:" from the wall surface
	C4 and C8	<p>CABLE MOUNT</p> <p>Mounting option includes:</p> <ul style="list-style-type: none"> • $\varnothing 1/16"$ x 48" (C4) or 96" (C8) aircraft cables • 60" (C4) or 108" (C8) power cable (in coordinating finish) • Bracket bars • $\varnothing 5"$ white canopies • Ceiling couplers • Side exit cable grippers

OPTIONS

ORDERING CODE	DESCRIPTION	SPECIFICATIONS
ED	EMERGENCY LED DRIVER	<ul style="list-style-type: none"> • Universal 120-277V input voltage emergency driver delivers initial minimum power of 10W for 90 minutes • Available for 4' or 8' nominal length non-dim or 0-10V fixture only (consult factory for all other lengths/drivers) • Indicator light/test switch located on housing side for surface mount and upper side for cable suspended mount

OCCUPANCY SENSOR

- Passive infrared occupancy sensor with hold-off daylighting adjustment (10-120 foot candles) and time delay adjustment from 30 seconds to 30 minutes
- Sensor adds 4" to overall fixture length
- Consult factory for custom output

S1A Occupancy sensor – position 1, 100% – 0%

Sensor located on the top at an end, with 100% – 0% light output setting

S1B Occupancy sensor – position 1, 100% – 50%

Sensor located on the top at an end, with 100% – 50% light output setting

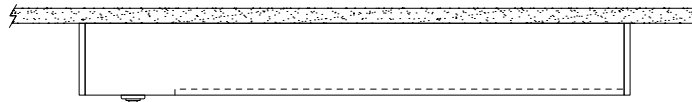

S2A Occupancy sensor – position 2, 100% – 0%

Sensor located on the side at the **right** end, with 100% – 0% light output setting

S2B Occupancy sensor – position 2, 100% – 50%

Sensor located on the side at the **right** end, with 100% – 50% light output setting

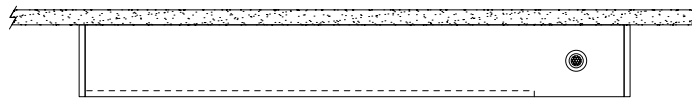

S3A Occupancy sensor – position 3, 100% – 0%

Sensor located on the side at the **left** end, with 100% – 0% light output setting

S3B Occupancy sensor – position 3, 100% – 50%

Sensor located on the side at the **left** end, with 100% – 50% light output setting

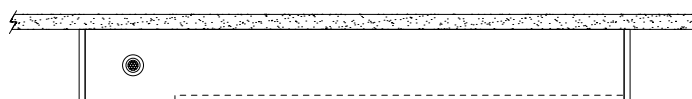

BSS214 | **bodhi**

3" square LED luminaire with flush lens

LENGTH/MOUNTING DIMENSIONS

ORDERING CODE	LENGTH A*	LENGTH B*	LENGTH C*	LENGTH D*	LENGTH E*
2	22-3/4"	22-1/2"	22-1/4"	16-3/4"	19-1/2"
3	33-3/4"	33-1/2"	33-1/4"	27-3/4"	30-1/2"
4	44-3/4"	44-1/2"	44-1/4"	38-3/4"	41-1/2"
5	55-3/4"	55-1/2"	55-1/4"	49-3/4"	52-1/2"
6	66-3/4"	66-1/2"	66-1/4"	60-3/4"	63-1/2"
7	77-3/4"	77-1/2"	77-1/4"	71-3/4"	74-1/2"
8	88-3/4"	88-1/2"	88-1/4"	82-3/4"	85-1/2"

RUN CONFIGURATION INFORMATION

ORDERING CODE	DESCRIPTION
SN	Single
ST	Starter
AD	Adder
TR	Terminator

* Add 4" to dimension for any fixture using the S1, S2 or S3 occupancy sensor option

RUN INFORMATION

Back Plan - Surface Mount Single Fixture Option

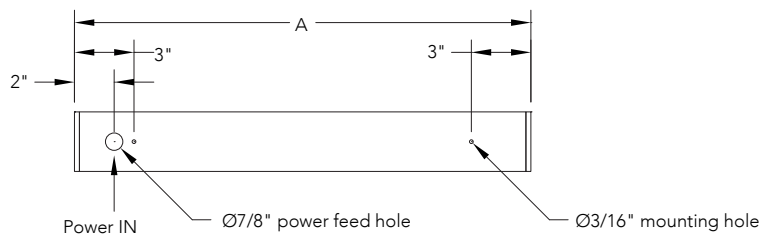

SN

Back Plan - Surface Mount Continuous Run Option

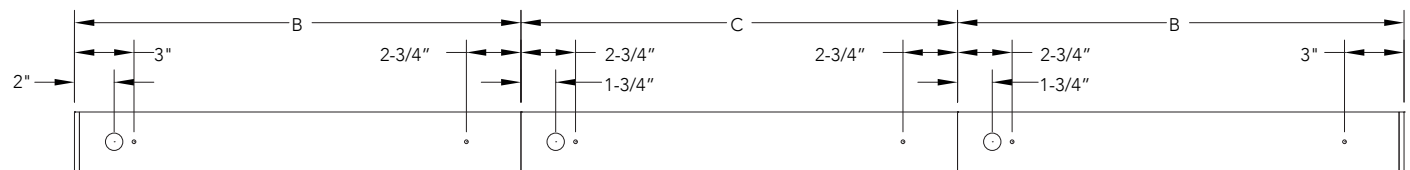

ST

AD

TR

Plan - Wall Mount Single Fixture Option

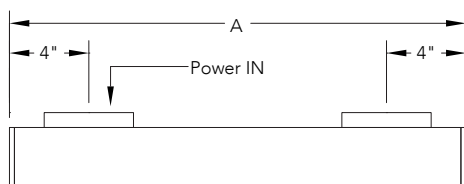

SN

