

BHR300 | HORIZON

2" wide aperture illuminated coffer LED luminaire

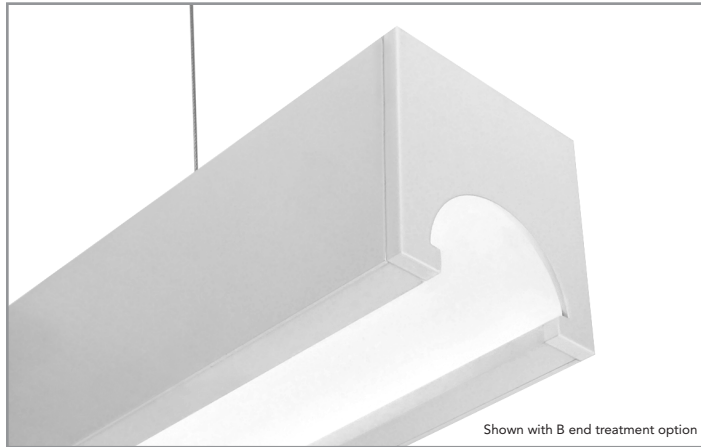

Project: _____ Type: _____



FEATURES

The Horizon BHR300 linear illuminated coffer luminaire provides clean, understated yet high performance general illumination. Housed in a 3-3/8" square extrusion, a visibly quiet, 2" wide illuminated coffer distributes light efficiently across a broad range. Surface and cable mounting options are available, as well as a variety of dimming drivers and light outputs, to maximize the versatility of this clean design luminaire.

SPECIFICATIONS

Fixture constructed of an extruded aluminum housing, chassis, and machined aluminum end caps

Model variations offered for surface and cable suspended applications

Coffer formed of 98% reflective material

Standard finishes as shown below

Available in nominal lengths of 2'-7' single fixtures and continuous runs

Basic continuous run fixtures provided with 18 ga. wiring harness for 6 Amp maximum load (consult factory for runs requiring multiple circuits, sensor integration, etc.)

LED modules, driver, and reflector are integrated into the chassis, which snaps into the outer housing for simple and quick installation

Standard integral 120-277V driver offered with 0-10V dimming or non-dim (other dimming driver options available)

Integral 120-277V emergency battery backup available for 4' nominal non-dim or 0-10V (consult factory for all other lengths/drivers)

Standard light outputs are 665, 880 and 1090 lumens per foot

LEDs available in 2700K, 3000K, 3500K, and 4000K, within a 3 step MacAdam ellipse, all with 90+ CRI typical

Life: 50,000 hours L₇₀

Limited five year warranty

UL and C-UL listed for dry and damp locations

SECTION

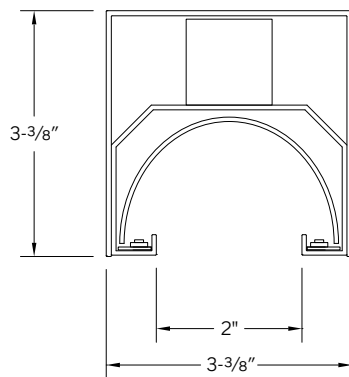

PERFORMANCE

NOMINAL LENGTH	OUTPUT	LUMENS/ft.	WATTS/ft.	LUMINAIRE LUMENS	EFFICACY
4'	L: low	665	6.8	2450	97
	R: regular	880	9.0	3251	98
	H: high	1090	11.5	4008	95

Note: All data reflects fixtures with 3500K LEDs



BHR300 -

NOMINAL FIXTURE LENGTH* 23: 22-11/16" 36: 35-3/4" 49: 49-1/4" 62: 62-5/16" 71: 71" 84: 84-5/16"	CORRELATED COLOR TEMPERATURE 27: 2700K-90+ CRI 30: 3000K-90+ CRI 35: 3500K-90+ CRI 40: 4000K-90+ CRI	DRIVER ND: non-dimming [Dimming] D: 0-10V, 1% DTR: triac, 1% DLV: electronic low voltage, 1% HES: Lutron EcoSystem, soft-on fade-to-black, 1% EL: eldoLED ECO-drive 0-10V, 1% ES: eldoLED SOLO-drive 0-10V, 0.1% ELD: eldoLED ECO-drive DALI, 1% ESD: eldoLED SOLO-drive DALI, 0.1%	LIGHT OUTPUT (lumens per foot) L: low – 665 R: regular – 880 H: high – 1090 CF: consult factory for custom output	MOUNT SM: surface mount C4: cable mount 4' cable length C8: cable mount 8' cable length CF: consult factory for custom mounting	RUN CONFIGURATION SN: single ST: starter AD: adder TR: terminator	END TREATMENT (for SN, ST, TR) A: solid square end cap B: arched flat end cap	OPTIONS ED: emergency driver (49" non-dim or 0-10V only) WS1A: Wattstopper FS-205, 100%-0% ‡ WS1B: Wattstopper FS-205, 100%-50% ‡ EN1: Enlighted FS-D22 ‡ ES1A: EasySense SNS102, 100%-0% ‡ ES1B: EasySense SNS102, 100%-50% ‡ ES2A: EasySense SNS200, 100%-0% ‡ ES2B: EasySense SNS200, 100%-50% ‡	FINISH AW: architectural white (semi-matte) WH: white (semi-gloss) BL: black (semi-matte) MB: matte black ESS: environmental satin silver BZ: bronze PR: primer CF: consult factory for custom finish SA: satin anodize (may require additional lead time)
--	---	---	--	--	--	--	--	--

* Actual dimension dependent on run configuration and sensor option
 ‡ See sensor section for driver compatibility information

MOUNTING

	ORDERING CODE	DESCRIPTION
	SM	<p>SURFACE MOUNT</p> <ul style="list-style-type: none"> Use appropriate fastener through $\varnothing 3/16"$ holes in housing
	C4 and C8	<p>CABLE MOUNT</p> <p>Mounting option includes:</p> <ul style="list-style-type: none"> $\varnothing 1/16"$ x 48" (C4) or 96" (C8) aircraft cables 60" (C4) or 108" (C8) power cable (in coordinating finish) Bracket bars $\varnothing 5"$ white canopies Ceiling couplers Cable grippers

END TREATMENT

Note: These options apply to SN, ST and TR configuration fixtures

	ORDERING CODE	DESCRIPTION	SPECIFICATIONS
	A	SOLID SQUARE CAP	1/4" thick, square machined aluminum end cap
	B	ARCHED OPENING CAP	1/4" thick machined aluminum end cap with arched opening

OPTIONS



	ORDERING CODE	DESCRIPTION	SPECIFICATIONS
	ED	EMERGENCY LED DRIVER	<ul style="list-style-type: none"> Universal 120-277V input voltage emergency driver delivers initial minimum power of 10W for 90 minutes Available for 4' nominal length non-dim or 0-10V fixture only (consult factory for all other lengths/drivers) Indicator/test switch located on the top for C4/C8 mount and on the side at an end for SM mount

BHR300 | HORIZON

2" wide aperture illuminated coffer LED luminaire

INTEGRATED SENSORS

Note: Sensor options add 3-1/2" to the overall fixture length.
Consult factory for custom light output setting.

	ORDERING CODE	LIGHT OUTPUT SETTING	BRAND AND MODEL	FUNCTIONS	NOTES
	WS1A	100% – 0%	Wattstopper FS-205	Occupancy and light level sensor	For use with on/off or 0-10V dimming drivers only
	WS1B	100% – 50%			
	EN1	Set during commissioning	Enlighted FS-D22	Occupancy, ambient light sensing, daylight harvesting, and environment monitoring for Enlighted control network	Provided with Advance sensor ready series 0-10V dimming drivers
	ES1A	100% – 0%	Philips EasySense SNS102	Occupancy, daylight harvesting and task tuning sensor with simple grouping	Provided with Advance sensor ready series 0-10V dimming drivers
	ES1B	100% – 50%			
	ES2A	100% – 0%	Philips EasySense SNS200	Occupancy, daylight harvesting and task tuning sensor with advance grouping	Provided with Advance sensor ready series 0-10V dimming drivers
	ES2B	100% – 50%			

LENGTH / MOUNTING DIMENSIONS

RUN CONFIGURATION INFORMATION

ORDERING CODE	LENGTH A	LENGTH B	LENGTH C	LENGTH D	LENGTH E
23	22-11/16"	22-7/16"	22-3/16"	16-11/16"	19-11/16"
36	35-3/4"	35-1/2"	35-1/4"	29-3/4"	32-3/4"
48	49-1/4"	49"	48-3/4"	43-1/4"	46-1/4"
62	62-5/16"	62-1/16"	61-13/16"	56-5/16"	59-5/16"
71	71"	70-3/4"	70-1/2"	65"	68"
84	84-5/16"	84-1/16"	83-13/16"	78-5/16"	81-5/16"

ORDERING CODE	DESCRIPTION
SN	Single
ST	Starter
AD	Adder
TR	Terminator

RUN INFORMATION

Back Plan - Surface Mount Single Fixture Option

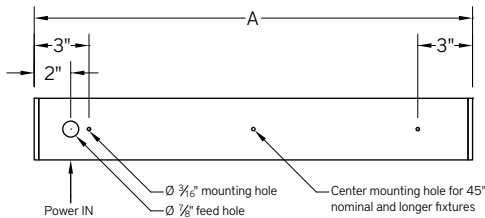

SN

Back Plan - Surface Mount Continuous Run Option

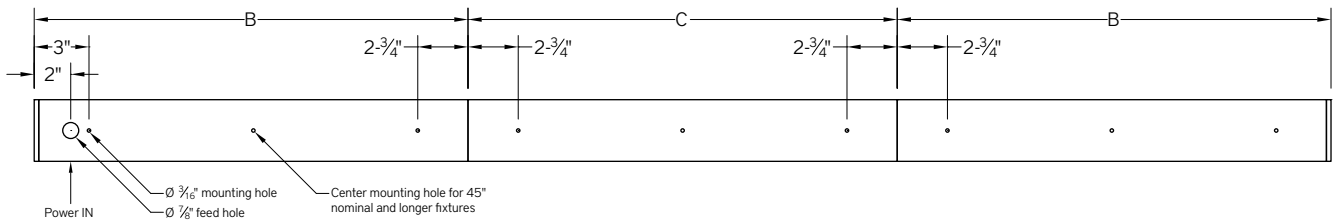

ST

AD

TR

Side View - Cable Mount Single Fixture Option

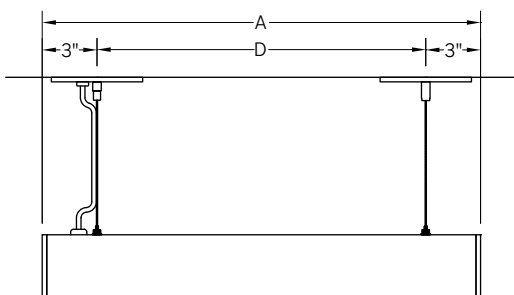

SN

RUN INFORMATION

Side View - Cable Mount Continuous Run Option

