

BSS255 | **bodhi**

2" wide direct/indirect LED luminaire

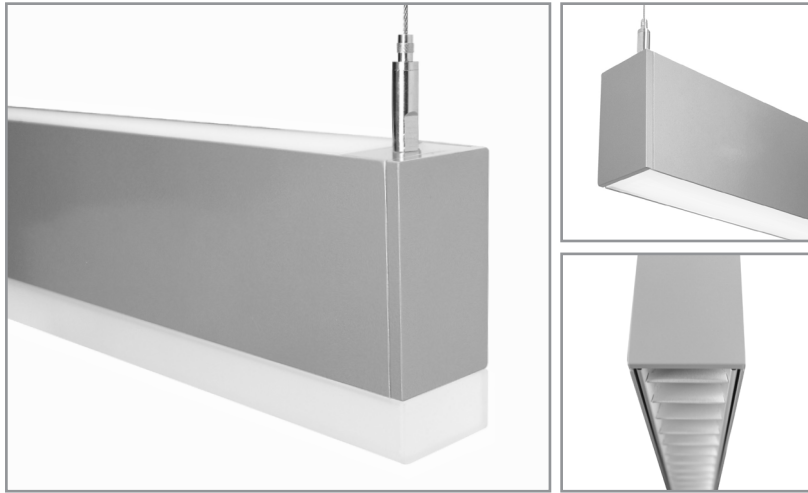

Project: _____ Type: _____



FEATURES

The Bodhi series BSS255 is a rectilinear direct/indirect LED luminaire for general lighting applications. The 2" wide by 3-1/2" high extruded aluminum housing is offered for wall or cable suspended mounting. The two LED sources can be configured independently for both switching and lumen output.

SPECIFICATIONS

Fixture constructed of extruded aluminum housing, extruded acrylic lenses and machined aluminum end caps

Model variations offered for wall mount and cable suspended applications with multiple optic options

Standard finishes as shown below

Available in nominal lengths of 2'-8' single fixtures and continuous runs

Basic continuous run fixtures provided with 18 ga. wiring harness for 6 Amp maximum load (consult factory for runs requiring multiple circuits, sensor integration, etc.)

Standard integral 120-277V driver offered with 0-10V dimming or non-dim (other dimming driver options available)

Integral 120-277V emergency battery backup available for 4' or 8' nominal, single circuit non-dim or 0-10V (consult factory for all other lengths/drivers)

Standard light outputs range from 470-790 lumens per foot for the direct source and 460 - 740 lumens per foot for the indirect source

LEDs available in 2700K, 3000K, 3500K and 4000K, within a 3 step MacAdam ellipse, all with 90+ CRI typical

Life: 50,000 hours L₇₀

Limited five year warranty

UL and C-UL listed for dry and damp locations

SECTION

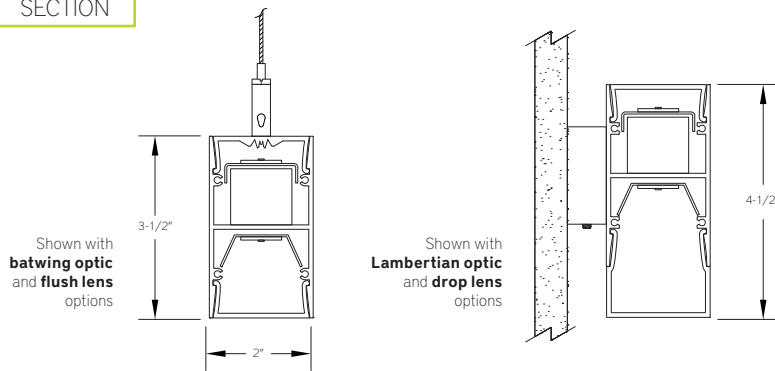

PERFORMANCE

NOMINAL LENGTH	OPTIC CONFIGURATION	OUTPUT	LUMENS/ft.	WATTS/ft.	LUMINAIRE LUMENS	EFFICACY (LPW)
4'	Indirect - Lambertian	L: low	465	5	1738	93
		R: regular	600	7.2	2257	84
	Indirect - batwing	L: low	570	5.7	2112	100
		R: regular	740	7.9	2743	94
	Direct - flush lens	L: low	470	5	1755	94
		R: regular	610	7.2	2279	85

OPTIC CONFIGURATION	OUTPUT	LUMENS/ft.	WATTS/ft.	LUMINAIRE LUMENS	EFFICACY (LPW)
Direct - drop lens, solid end	L: low	500	5	1850	99
	R: regular	650	7.2	2402	90
Direct - flush lens, asymmetric	L: low	580	5.4	2155	108
	R: regular	790	7.6	2933	103

Note: All data reflects fixtures with 3500K LEDs



BSS255 -

* Actual dimension dependent on run configuration.

NOMINAL FIXTURE LENGTH* 2: 22-5/8" 3: 33-5/8" 4: 44-5/8" 5: 55-5/8" 6: 66-5/8" 7: 77-5/8" 8: 88-5/8"	DRIVER ND: non-dimming [Dimming] D: 0-10V, 1% DTR: triac, 1% DLV: electronic low voltage, 1% HES: Lutron EcoSystem, soft-on fade-to-black, 1% EL: eldoLED ECOdrive 0-10V, 1% ES: eldoLED SOLOdrive 0-10V, 0.1% ELD: eldoLED ECOdrive DALI, 1% ESD: eldoLED SOLOdrive DALI, 0.1%	INDIRECT LIGHT OUTPUT (lumens per foot w/optic option 1) L: low - 465 R: regular - 600 CF: consult factory for custom output	INDIRECT OPTIC 1: general Lambertian distribution 2: batwing distribution	MOUNT C4: cable mount 4' cable length C8: cable mount 8' cable length WM: wall mount CF: consult factory for custom mounting	OPTIONS ED: emergency driver (4' or 8' SINGLE CIRCUIT, non-dim or 0-10V only)	FINISH AW: architectural white (semi-matte) WH: white (semi-gloss) BL: black (semi-matte) MB: matte black ESS: environmental satin silver BZ: bronze PR: primer CF: consult factory for custom finish
CORRELATED COLOR TEMPERATURE 27: 2700K-90+ CRI 30: 3000K-90+ CRI 35: 3500K-90+ CRI 40: 4000K-90+ CRI		CIRCUIT 1: single circuit 2: two circuit (4' nom. length and longer)	DIRECT LIGHT OUTPUT (lumens per foot w/optic option B) L: low - 500 R: regular - 650 CF: consult factory for custom output	DIRECT OPTIC A: flush lens B: drop lens - solid end C: drop lens - luminous end D: louver (4' and 8' only) E: flush lens - asymmetric distribution	RUN CONFIGURATION SN: single ST: starter AD: adder TR: terminator	SA: satin anodize (may require additional lead time)

INDIRECT OPTIC OPTION

ORDERING CODE	DESCRIPTION	SPECIFICATIONS
1	LAMBERTIAN DISTRIBUTION	Frosted extruded acrylic lens for general Lambertian distribution
2	BATWING DISTRIBUTION	Clear extruded acrylic with wide distribution optic features

DIRECT OPTIC OPTION

ORDERING CODE	DESCRIPTION	SPECIFICATIONS
A	FLUSH LENS	Flush frosted acrylic extrusion
B	DROP LENS - SOLID END	1" H frosted acrylic extrusion with full height aluminum end cap
C	DROP LENS - LUMINOUS END	1" H frosted acrylic extrusion with matching acrylic end cap
D	LOUVER	Parabolic louver with 5/8" blades at 1" spacing, formed from diffuse, high reflectance aluminum and supplied with light diffusion film. Available for 4' and 8' nominal length fixtures.
E	FLUSH LENS - ASYMMETRIC DISTRIBUTION	Flush frosted acrylic extrusion for direct asymmetric distribution

MOUNTING

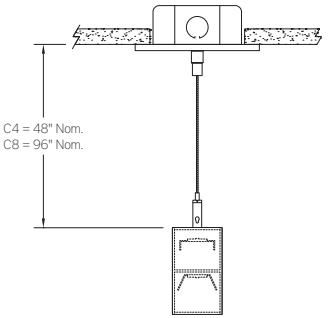
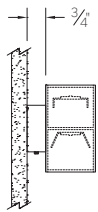
	ORDERING CODE	DESCRIPTION
	C4 and C8	<p>CABLE MOUNT</p> <p>Mounting option includes:</p> <ul style="list-style-type: none"> • Ø 1/16" x 48" (C4) or 96" (C8) aircraft cables • 60" (C4) or 108" (C8) power cable in coordinating finish • Bracket bars • Ø 5" white canopies • Ceiling couplers • Side exit cable grippers <p>NOTE: WHEN DUAL CIRCUIT OPTION IS USED, TWO POWER CABLES ARE REQUIRED</p>
	WM	<p>WALL MOUNT</p> <p>Mounting option includes:</p> <ul style="list-style-type: none"> • 1-7/8"H x 2-1/2"W aluminum bracket projects the fixture housing 3/4" from the wall surface

OPTIONS

ORDERING CODE	DESCRIPTION	SPECIFICATIONS
ED	EMERGENCY LED DRIVER	<ul style="list-style-type: none"> • Universal 120-277V input voltage emergency driver delivers initial minimum power of 10W for 90 minutes • Available for SINGLE CIRCUIT 4' or 8' nominal length non-dim or 0-10V fixture and direct light source only (consult factory for all other lengths/drivers)

LENGTH/MOUNTING DIMENSIONS

ORDERING CODE	LENGTH A	LENGTH B	LENGTH C	LENGTH D	LENGTH E
2	22-5/8"	22-3/8"	22-1/8"	21-1/8"	21-5/8"
3	33-5/8"	33-3/8"	33-1/8"	32-1/8"	32-5/8"
4	44-5/8"	44-3/8"	44-1/8"	43-1/8"	43-5/8"
5	55-5/8"	55-3/8"	55-1/8"	54-1/8"	54-5/8"
6	66-5/8"	66-3/8"	66-1/8"	65-1/8"	65-5/8"
7	77-5/8"	77-3/8"	77-1/8"	76-1/8"	76-5/8"
8	88-5/8"	88-3/8"	88-1/8"	87-1/8"	87-5/8"

RUN CONFIGURATION INFORMATION

ORDERING CODE	DESCRIPTION
SN	Single
ST	Starter
AD	Adder
TR	Terminator

RUN INFORMATION

Plan - Wall Mount Single Fixture Option

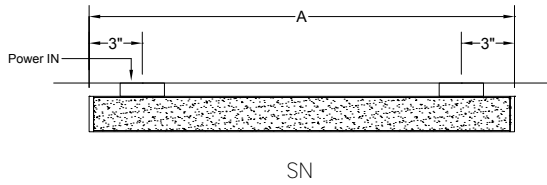

SN

Plan - Wall Mount Continuous Run Option

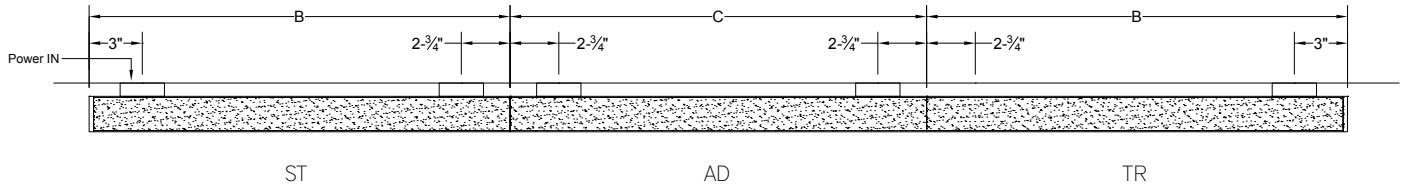

ST

AD

TR

Side View - Cable Suspended Single Fixture Option

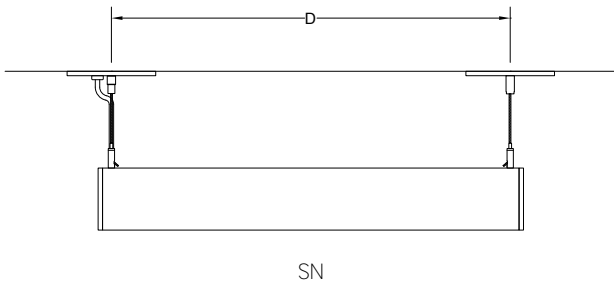

SN

Side View - Cable Suspended Continuous Run Option

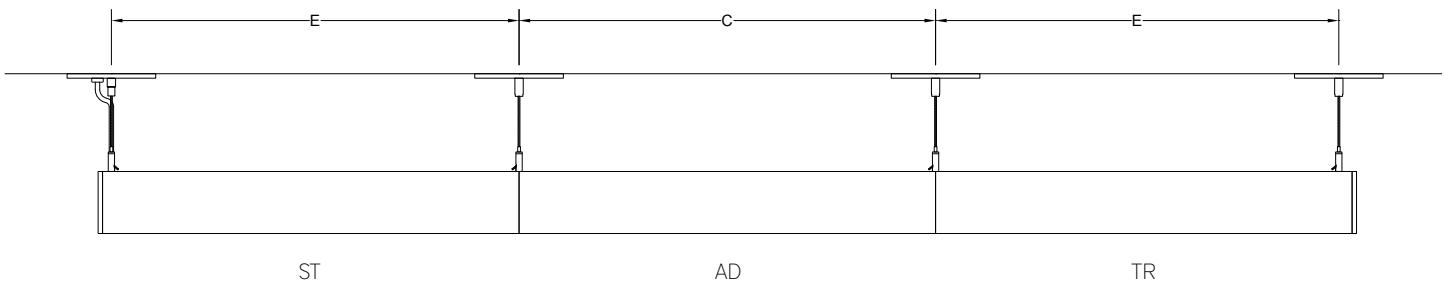

ST

AD

TR