

BSS755 | WEDGE

4-1/4" square corner mount LED luminaire

Project: _____ Type: _____

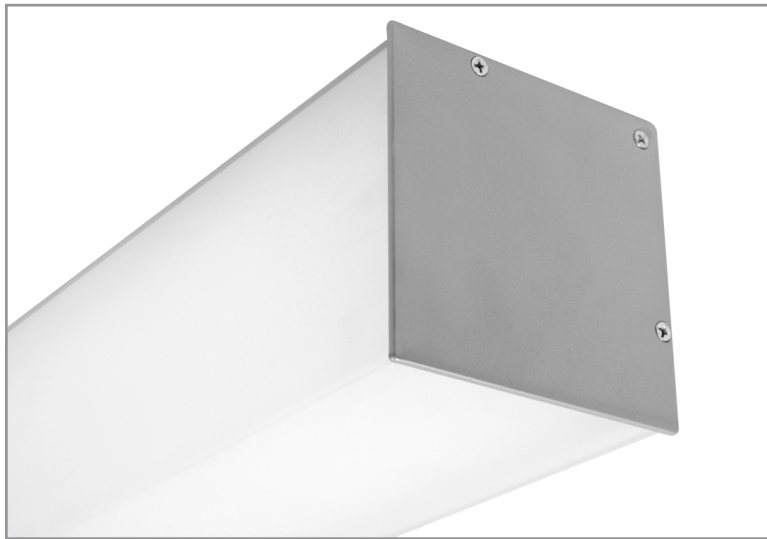

FEATURES

The BSS755 is a corner mount, linear LED luminaire well suited for perimeter and stairwell lighting. The 4-1/4" x 4-1/4" extruded aluminum housing tucks into architectural junctures and is fitted with a two-sided, frosted acrylic lens. When installed, virtually no fixture housing is visible, leaving the evenly illuminated lens to make a strong visual statement.

SPECIFICATIONS

Fixture constructed of an extruded aluminum housing, frosted, extruded acrylic lens and sheet aluminum end caps

Model variations offered for surface and pendant mount applications

Standard finishes as shown below

Available in nominal lengths of 2'-8' single fixtures and continuous runs

Basic continuous run fixtures provided with 18 ga. wiring harness for 6 Amp maximum load (consult factory for runs requiring multiple circuits, sensor integration, etc.)

One Ø 7/8" knock-out provided on both the top and back sides at the left end of the fixture

Standard 120-277V integral driver offered with 0-10V dimming or non-dim (other dimming driver options available)

Integral 120-277V emergency battery backup available for 4' or 8' nominal non-dim or 0-10V (consult factory for all other lengths/ drivers)

Standard light outputs are 770, 1000 or 1310 lumens per foot

LEDs available in 3000K, 3500K, and 4000K, within a 3 step MacAdam ellipse, all with 80+ CRI typical

Life: 50,000 hours L₇₀

Limited five year warranty

UL and C-UL listed for dry and damp locations

SECTION

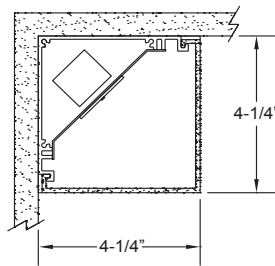

PERFORMANCE

Note: All data reflects fixtures with 3500K LEDs

NOMINAL LENGTH	OUTPUT	LUMENS/ft.	WATTS/ft.	LUMINAIRE LUMENS	EFFICACY (LPW)
4'	L: low	770	6.0	2881	128
	R: regular	1000	9.4	3742	107
	H: high	1310	13.6	4917	96



BSS755 -

NOMINAL FIXTURE LENGTH*	CORRELATED COLOR TEMPERATURE	DRIVER	LIGHT OUTPUT (lumens per foot)	MOUNT	RUN CONFIGURATION	FINISH
2: 22-9/16"	30: 3000K-80+ CRI	ND: non-dimming	L: low - 770	SM: surface mount	SN: single	AW: architectural white (semi-matte)
3: 33-5/8"	35: 3500K-80+ CRI	[Dimming]	R: regular - 1000	PM18: pendant mount 18" stem length	ST: starter	WH: white (semi-gloss)
4: 44-11/16"	40: 4000K-80+ CRI	DM: 0-10V, 1%	H: high - 1310	PM24: pendant mount 24" stem length	AD: adder	BL: black (semi-matte)
5: 55-3/4"		HES: Lutron EcoSystem, soft-on/fade-to-black, 1%	CF: consult factory for custom output	PM30: pendant mount 30" stem length	TR: terminator	MB: matte black
6: 66-13/16"		H2: Lutron Hi-lume 2-wire forward phase, 1%, (120V ONLY)		CF: consult factory for custom mounting		ESS: environmental satin silver
7: 77-7/8"		EL: eldoLED ECOdrive 0-10V, 1%				BZ: bronze
8: 88-15/16"		ES: eldoLED SOLOdrive 0-10V, 0.1%				PR: primer
		ELD: eldoLED ECOdrive DALI, 1%				CF: consult factory for custom finish
		ESD: eldoLED SOLOdrive DALI, 0.1%				SA: satin anodize (may require additional lead time)

OPTIONS

ED: emergency driver (4' or 8' non-dim or 0-10V only)

* Actual dimension dependent on mounting option and run configuration

BSS755 | WEDGE

4-1/4" square corner mount LED luminaire

OPTIONS

	ORDERING CODE	DESCRIPTION	SPECIFICATIONS
	ED	EMERGENCY LED DRIVER	<ul style="list-style-type: none"> • Universal 120-277V input voltage emergency driver delivers initial minimum power of 10W for 90 minutes • Available for 4' or 8' nominal length non-dim or 0-10V fixture only (consult factory for all other lengths/ drivers) • Provided with combination test switch/indicator light mounted to wall plate for remote installation

MOUNTING

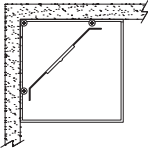
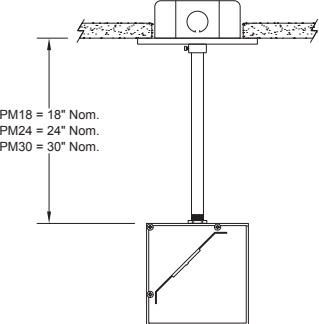
	ORDERING CODE	DESCRIPTION
	SM	<p>SURFACE MOUNT</p> <ul style="list-style-type: none"> • Use appropriate fastener through $\varnothing 3/16"$ holes in housing
 <p>PM18 = 18" Nom. PM24 = 24" Nom. PM30 = 30" Nom.</p>	PM18, PM24, PM30	<p>PENDANT MOUNT</p> <p>Mounting option includes:</p> <ul style="list-style-type: none"> • $\varnothing 1/2"$ x 18" (PM18), 24" (PM24) or 30" (PM30) white steel stems • 18 gauge power leads 12" longer than the stem length (on SN, ST fixtures) • Bracket bars and hex nuts • $\varnothing 5"$ white canopies with integrated slip ring

LENGTH / MOUNTING DIMENSIONS

ORDERING CODE	LENGTH A	LENGTH B	LENGTH C	LENGTH D	LENGTH E
2	22-9/16"	22-5/16"	22-1/16"	16-9/16"	19-5/16"
3	33-5/8"	33-7/16"	33-3/16"	27-5/8"	30-7/16"
4	44-11/16"	44-1/2"	44-1/4"	38-11/16"	41-1/2"
5	55-3/4"	55-9/16"	55-5/16"	49-3/4"	52-9/16"
6	66-13/16"	66-5/8"	66-3/8"	60-13/16"	63-5/8"
7	77-7/8"	77-11/16"	77-7/16"	71-7/8"	74-11/16"
8	88-15/16"	88-3/4"	88-1/2"	82-15/16"	85-3/4"

RUN CONFIGURATION INFORMATION

ORDERING CODE	DESCRIPTION
SN	Single
ST	Starter
AD	Adder
TR	Terminator

RUN INFORMATION

Top View - Surface Mount Single Fixture Option

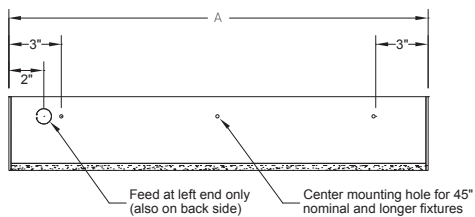

Front View - Surface Mount Single Fixture Option

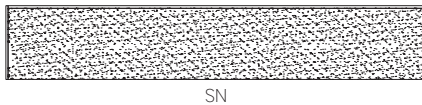

Top View - Surface Mount Continuous Fixture Option

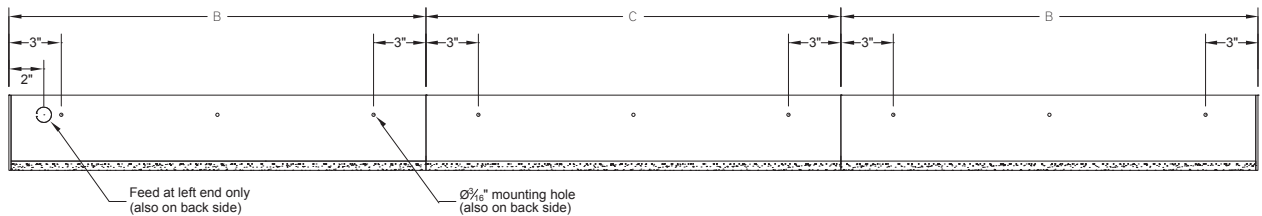

Front View - Surface Mount Continuous Fixture Option

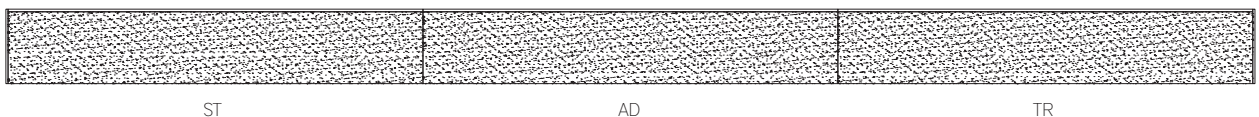

BSS755 | WEDGE

4-1/4" square corner mount LED luminaire

RUN INFORMATION

Side View - Pendant Mount Single Fixture Option

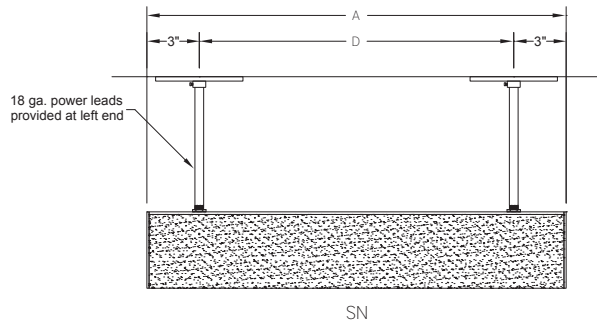

Side View - Pendant Mount Continuous Fixture Option

