

# BSS750 | WEDGE

3" square corner mount LED luminaire

Project: \_\_\_\_\_ Type: \_\_\_\_\_



## FEATURES

The BSS750 is a corner mount, linear LED luminaire well suited for perimeter and stairwell lighting. The 3" x 3" extruded aluminum housing tucks into architectural junctures and is fitted with a two-sided, frosted acrylic lens. When installed, virtually no fixture housing is visible, leaving the evenly illuminated lens to make a strong visual statement.

## SPECIFICATIONS

Fixture constructed of an extruded aluminum housing, frosted, extruded acrylic lens and sheet aluminum end caps

Model variations offered for surface and pendant mount applications

Standard finishes as shown below

Available in nominal lengths of 2'-8' single fixtures and continuous runs

Basic continuous run fixtures provided with 18 ga. wiring harness for 6 Amp maximum load (consult factory for runs requiring multiple circuits, sensor integration, etc.)

One Ø 7/8" knock-out provided on both the top and back sides at the left end of the fixture

Standard 120-277V integral driver offered with 0-10V dimming or non-dim (other dimming driver options available)

Integral 120-277V emergency battery backup available for 4' or 8' nominal non-dim or 0-10V (consult factory for all other lengths/drivers)

Standard light outputs are 750, 970 or 1275 lumens per foot

LEDs available in 3000K, 3500K, and 4000K, within a 3 step MacAdam ellipse, all with 80+ CRI typical

Life: 50,000 hours L<sub>70</sub>

Limited five year warranty

UL and C-UL listed for dry and damp locations

## SECTION

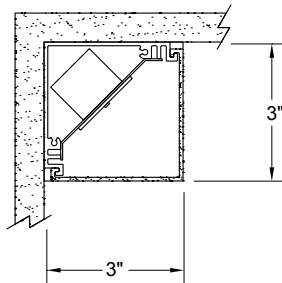

## PERFORMANCE

Note: All data reflects fixtures with 3500K LEDs

NOMINAL LENGTH	OUTPUT	LUMENS/ft.	WATTS/ft.	LUMINAIRE LUMENS	EFFICACY (LPW)
4'	L: low	750	5.6	2275	134
	R: regular	970	8.6	3604	113
	H: high	1275	12.7	4736	101



## BSS750 -

NOMINAL FIXTURE LENGTH*	CORRELATED COLOR TEMPERATURE	DRIVER	LIGHT OUTPUT (lumens per foot)	MOUNT	RUN CONFIGURATION	FINISH
2: 22-9/16"	30: 3000K-80+ CRI	ND: non-dimming	L: low - 750	SM: surface mount	SN: single	AW: architectural white (semi-matte)
3: 33-5/8"	35: 3500K-80+ CRI	[Dimming]	R: regular - 970	PM18: pendant mount 18" stem length	ST: starter	WH: white (semi-gloss)
4: 44-11/16"	40: 4000K-80+ CRI	D: 0-10V, 1%	H: high - 1275	PM24: pendant mount 24" stem length	AD: adder	BL: black (semi-matte)
5: 55-3/4"		HES: Lutron EcoSystem, soft-on/fade-to-black, 1%	CF: consult factory for custom output	PM30: pendant mount 30" stem length	TR: terminator	MB: matte black
6: 66-13/16"		H2: Lutron Hi-lume 2-wire forward phase, 1%, (120V ONLY)		CF: consult factory for custom mounting		ESS: environmental satin silver
7: 77-7/8"		EL: eldoLED				BZ: bronze
8: 88-15/16"		ECOdrive, 0-10V, 1%				PR: primer
						CF: consult factory for custom finish
					<b>OPTIONS</b>	SA: satin anodize (may require additional lead time)
					ED: emergency driver (4' or 8' non-dim or 0-10V only)	

\* Actual dimension dependent on mounting option and run configuration

# BSS750 | WEDGE

3" square corner mount LED luminaire

## OPTIONS

	ORDERING CODE	DESCRIPTION	SPECIFICATIONS
	ED	EMERGENCY LED DRIVER	<ul style="list-style-type: none"> <li>• Universal 120-277V input voltage emergency driver delivers initial minimum power of 10W for 90 minutes</li> <li>• Available for 4' or 8' nominal length non-dim or 0-10V fixture only (consult factory for all other lengths/drivers)</li> <li>• Provided with combination test switch/indicator light mounted to wall plate for remote installation</li> </ul>

## MOUNTING

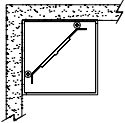
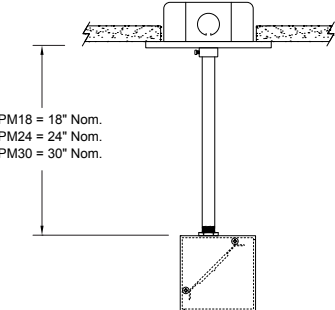
	ORDERING CODE	DESCRIPTION
	SM	<p>SURFACE MOUNT</p> <ul style="list-style-type: none"> <li>• Use appropriate fastener through <math>\text{Ø}3/16''</math> holes in housing</li> </ul>
 <p>PM18 = 18" Nom. PM24 = 24" Nom. PM30 = 30" Nom.</p>	PM18, PM24, PM30	<p>PENDANT MOUNT</p> <p>Mounting option includes:</p> <ul style="list-style-type: none"> <li>• <math>\text{Ø} 1/2'' \times 18''</math> (PM18), 24" (PM24) or 30" (PM30) white steel stems</li> <li>• 18 gauge power leads 12" longer than the stem length (on SN, ST fixtures)</li> <li>• Bracket bars and hex nuts</li> <li>• <math>\text{Ø} 5''</math> white canopies with integrated slip ring</li> </ul>

## LENGTH / MOUNTING DIMENSIONS

## RUN CONFIGURATION INFORMATION

ORDERING CODE	LENGTH A	LENGTH B	LENGTH C	LENGTH D	LENGTH E
2	22-9/16"	22-5/16"	22-1/16"	16-9/16"	19-5/16"
3	33-5/8"	33-7/16"	33-3/16"	27-5/8"	30-7/16"
4	44-11/16"	44-1/2"	44-1/4"	38-11/16"	41-1/2"
5	55-3/4"	55-9/16"	55-5/16"	49-3/4"	52-9/16"
6	66-13/16"	66-5/8"	66-3/8"	60-13/16"	63-5/8"
7	77-7/8"	77-11/16"	77-7/16"	71-7/8"	74-11/16"
8	88-15/16"	88-3/4"	88-1/2"	82-15/16"	85-3/4"

ORDERING CODE	DESCRIPTION
SN	Single
ST	Starter
AD	Adder
TR	Terminator

## RUN INFORMATION

Top View - Surface Mount Single Fixture Option

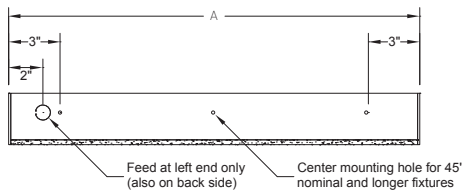

Front View - Surface Mount Single Fixture Option

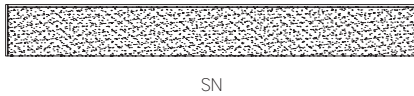

Top View - Surface Mount Continuous Fixture Option

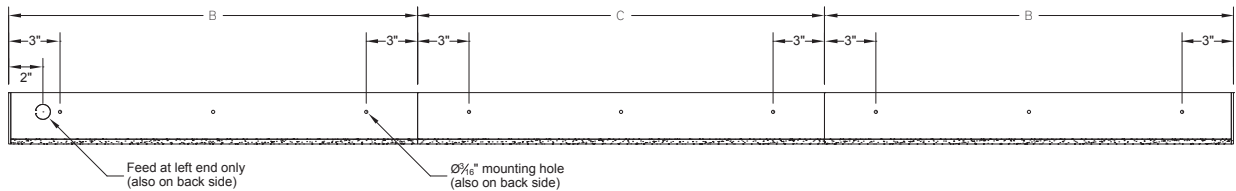

Front View - Surface Mount Continuous Fixture Option

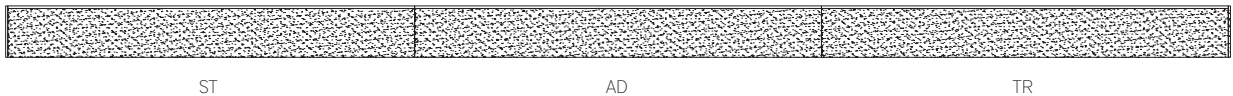

Side View - Pendant Mount Single Fixture Option

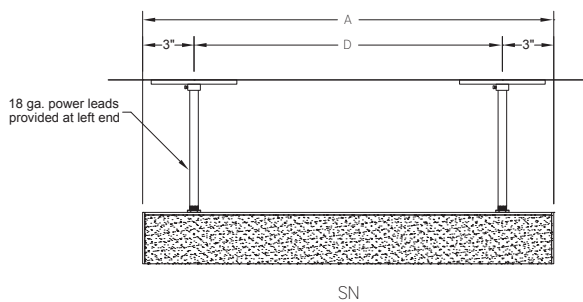

# BSS750 | WEDGE

3" square corner mount LED luminaire

## RUN INFORMATION

Side View - Pendant Mount Continuous Fixture Option

