

BSS501 | TUBULAR

Ø1-3/8" arm mount LED luminaire, remote driver

Project: _____ Type: _____

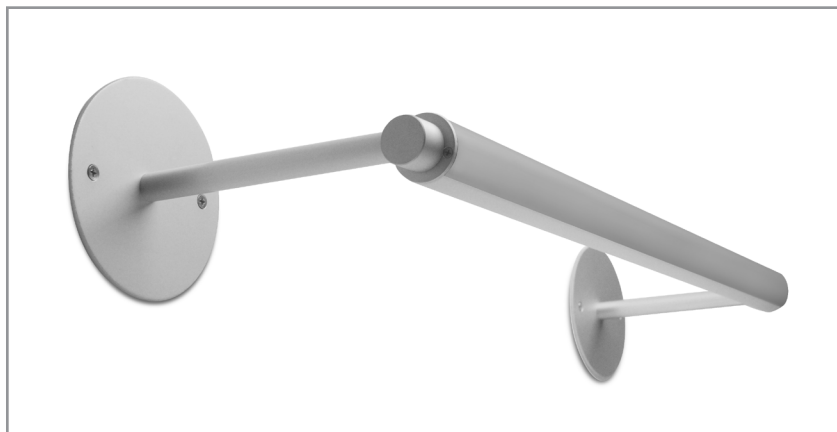

FEATURES

Part of the Tubular family of LED luminaires, the BSS501 is an arm mounted model ideally suited for wall wash and stack lighting. Slender aluminum arms project the Ø1-3/8" extruded aluminum housing from a wall or ceiling, while machined aluminum couplers allow a generous range of rotation for flexible aiming. The BSS501 is fitted with 90+ CRI LEDs and is available with a Lambertian or asymmetric lens optic.

SPECIFICATIONS

Fixture housing constructed of an extruded aluminum tube, frosted acrylic extruded lens and sheet aluminum end caps

Fixture arms are constructed of steel pipe, Ø5/8" extruded aluminum sleeves and machined aluminum end cap couplers.

Mounting plate options include a Ø4-3/4" aluminum plate for mounting to 4" octagonal wall boxes or Ø1-3/8" aluminum plate for mounting to accessible panels.

Standard finishes as shown below

Single and continuous run fixtures available with arm center distances of 24"-90"

Arms allow fixture to project from a wall or ceiling nominally 3", 6", 12" or 18"

Fixture housing rotates 332° and is locked in place with hex fastener

Included standard remote 120-277V driver offered with 0-10V dimming or non-dim (other dimming driver options available)

Extruded acrylic lens options available for Lambertian or asymmetric light distributions

Fixture wired with 10', low voltage leads (measured from the end cap)

Standard outputs range from 400 to 535 lumens per foot, dependent on optic

LEDs available in 2700K, 3000K, 3500K, and 4000K, within a 3 step MacAdam ellipse, all with 90+ CRI typical

Life: 50,000 hours L₇₀

Limited five year warranty

UL and C-UL listed for dry and damp locations

PROFILE

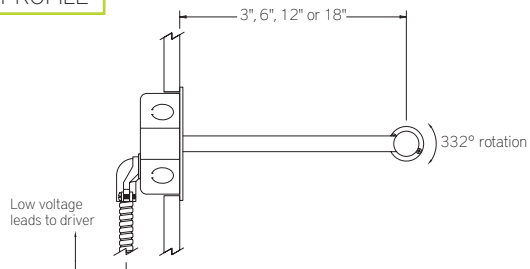

SECTION

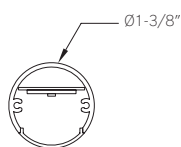

PERFORMANCE

Note: All data reflects fixtures with 3500K LEDs

NOMINAL LENGTH	OPTIC OPTION	OUTPUT	LUMENS/ft.	WATTS/ft.	LUMINAIRE LUMENS	EFFICACY (LPW)
4'	Lambertian	L: low	400	3.9	1675	102
		R: regular	520	5.6	2175	92
	Asymmetric	L: low	415	3.9	1735	106
		R: regular	535	5.6	2253	96



BSS501 -

ARM CENTER DISTANCE

24: 24"
28: 27-11/16"
31: 31-3/8"
35: 35"
39: 38-11/16"
42: 42-3/8"
46: 46"
50: 49-11/16"
53: 53-3/8"
57: 57"
61: 60-11/16"
64: 64-3/8"
68: 68"
72: 71-11/16"

CORRELATED COLOR TEMPERATURE

27: 2700K-90+ CRI
30: 3000K-90+ CRI
35: 3500K-90+ CRI
40: 4000K-90+ CRI

75: 75-3/8"
79: 79"

83: 82-11/16"
86: 86-3/8"
90: 90"
94: 93-11/16"
97: 97-3/8"

DRIVER

ND: non-dimming
[Dimming]
 D: 0-10V, 1%
 DTR: triac, 1%
 DLV: electronic low voltage, 1%
 HES: Lutron Eco-System, soft-on fade-to-black, 1%
 EL: eldoLED ECO-drive 0-10V, 1%
 ES: eldoLED SOLO-drive 0-10V, 0.1%
 ELD: eldoLED ECOdrive DALI, 1%
 ESD: eldoLED SOLOdrive DALI, 0.1%

LIGHT OUTPUT (lumens per foot w/optic option L)

L: low - 400
 R: regular - 520
 CF: consult factory for custom output

OPTIC

L: Lambertian distribution
 A: asymmetric distribution

NOMINAL ARM LENGTH

3: 3"
 6: 6"
 12: 12"
 18: 18"
 CF: consult factory for custom arm length

MOUNTING PLATE OPTION

WBR: wall box plate
 TP: trim plate

RUN CONFIGURATION

SN: single
 ST: starter
 AD: adder
 TR: terminator

FINISH

AW: architectural white (semi-matte)
 WH: white (semi-gloss)
 BL: black (semi-matte)
 MB: matte black
 ESS: environmental satin silver
 BZ: bronze
 PR: primer
 CF: consult factory for custom finish
 SA: satin anodize (may require additional lead time)

Note: Each fixture includes a remote driver matched for fixture length and light output.

OPTIC OPTION

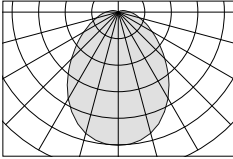
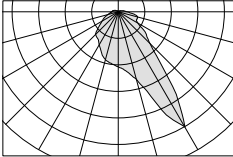
	ORDERING CODE	DESCRIPTION
	L	Lambertian light distribution
	A	Asymmetric light distribution

MOUNTING PLATE OPTION

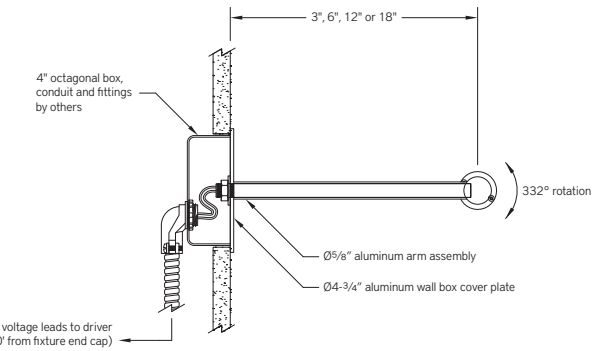
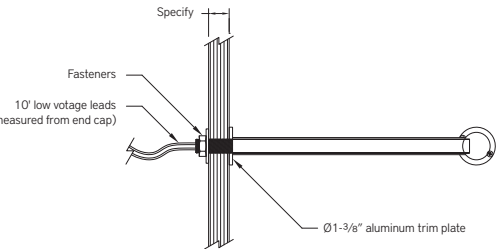
	ORDERING CODE	DESCRIPTION
	WBR	<p>WALL BOX MOUNTING PLATE</p> <ul style="list-style-type: none"> • Ø4-3/4" x 1/8" sheet aluminum plate in matching finish for mounting to 4" octagonal junction box (by others) • Includes flat head Phillips machine screws
	TP	<p>TRIM PLATE</p> <ul style="list-style-type: none"> • Ø1-3/8" x 1/8" sheet aluminum plate in matching finish for mounting to a panel with access to the back side • Includes 10' low voltage leads (measured from end cap), flat washer and hex nut • Accommodates panel thickness up to 3/4" – (consult factory for special mounting conditions)

ARM CENTER DISTANCE

ORDERING CODE	LENGTH A	ORDERING CODE	LENGTH A	ORDERING CODE	LENGTH A
24	24"	50	49-11/16"	75	75-3/8"
28	27-11/16"	53	53-3/8"	79	79"
31	31-3/8"	57	57"	83	82-11/16"
35	35"	61	60-11/16"	86	86-3/8"
39	38-11/16"	64	64-3/8"	90	90"
42	42-3/8"	68	68"	94	93-11/16"
46	46"	72	71-11/16"	97	97-3/8"

RUN CONFIGURATION INFORMATION

ORDERING CODE	DESCRIPTION
SN	Single
ST	Starter
AD	Adder
TR	Terminator

RUN INFORMATION

Single Fixtures

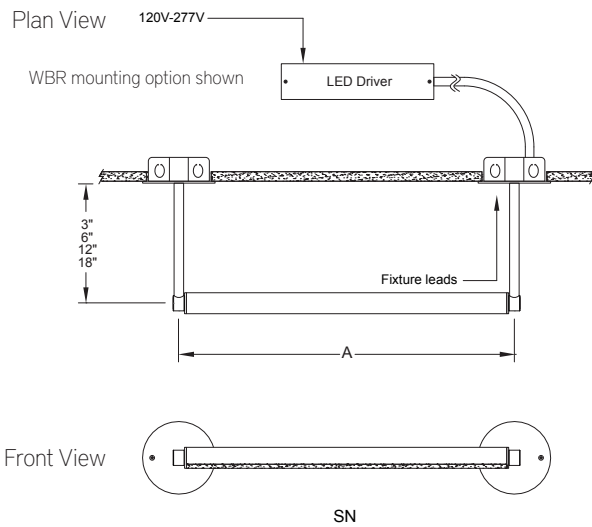

Continuous Runs

