

IST5R | ELYTRON COLLECTION

Round top, linear T5 fluorescent fixture with lens and decorative end caps

Project: _____

Type: _____

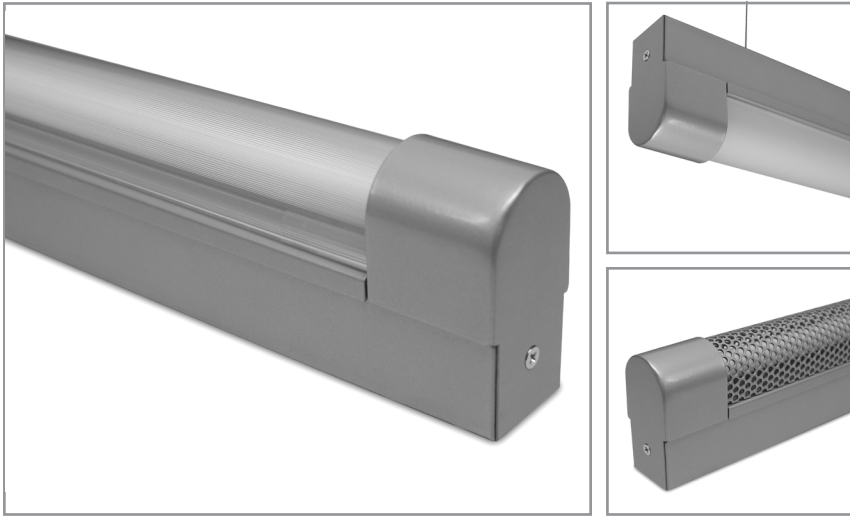

FEATURES

The Elytron Collection features clean, linear fixture bodies and simple decorative caps to conceal the darkness associated with the ends of T5 lamps and sockets. Though kept to a minimum, the profile is still large enough to accept a wide variety of popular ballasts. Multiple lens and three mounting options further broaden the versatility of this sleek luminaire.

SPECIFICATIONS

Fully assembled housing is formed and welded, 20 ga. steel, chemically treated to resist corrosion and enhance paint adhesion

Model variations offered for surface, cable suspended and pendant mount applications

Available in standard white, black, silver, platinum, bronze and primer powder coat, applied post production (consult factory for custom finishes)

Lens options include linear prismatic and frosted acrylic lens or perforated steel cover

Available for T5 14W, 21W, 28W, 35W and high output 24W, 39W, 54W, 80W linear fluorescent lamps in single, some tandem lengths and continuous runs

Standard ballast is specification grade 120V-277V program start (consult factory for other voltage options)

Dimming, emergency battery backup and specialized ballast factor options available (refer to supplemental ballast details sheet for availability)

Knock-outs on back of surface mount model accept standard electrical fittings by others (consult factory for other locations)

Rotational locking lamp holders

UL and C-UL listed for dry and damp locations

IBEW manufactured and labeled

Made in the U.S.A.

PROFILE

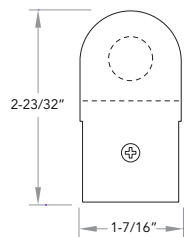

PLAN

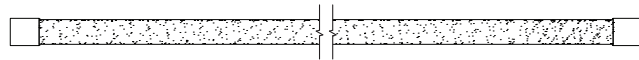

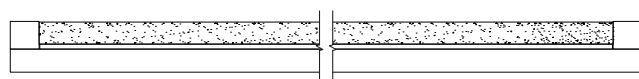

SIDE



IST5R +

WATTS	VOLTAGE	BALLAST	LENS	MOUNT	FINISH
14: 14W 21: 21W 28: 28W 35: 35W 24: 24W HO 39: 39W HO 54: 54W HO 80: 80W HO 2121: 2x21W 2828: 2x28W 3939: 2x39W HO 5454: 2x54W HO	U: 120V-277V 347: 347V CF: consult factory for specialize voltage [Non-Dimming] PRS: program rapid start [Dimming] MKX: Advance Mark 10 VII: Advance Mark 7 ESYS: Lutron EcoSystem EHD: Lutron EcoSystem H HLM: Lutron Hi-Lume H300: Lutron Hi-Lume 3D PHO: Sylvania Helios DALI: Dali T5 (consult factory) SD95-50: Universal BallaSTAR SD115-50: Universal BallaSTAR	[Custom Performance] PH: 1.15BF program start PN85: 0.85BF program start PN90: 0.90BF program start PN95: 0.95BF program start [Emergency] I28: Iota ISL-28 I54: Iota ISL-54 I540: Iota ISL-540-35W L50: Bodine LP500 L55: Bodine LP5500	F: frosted P: linear prismatic Perf: perforated steel cover SM: surface mount CM48: cable mount 48" cable length CM96: cable mount 96" cable length PM18: pendant mount 18" stem length PM24: pendant mount 24" stem length PM30: pendant mount 30" stem length CF: consult factory for custom mounting	RUN CONFIGURATION SIN: single STA: starter ADD: adder TER: terminator	WH: white BL: black SL: silver PT: platinum BZ: bronze PR: primer CF: consult factory for custom color

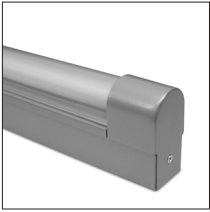
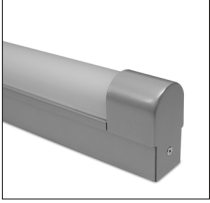
LENS OPTIONS

	ORDERING CODE	DESCRIPTION
	P	Linear prismatic acrylic lens
	F	Frosted acrylic lens
	PERF	Perforated steel cover in matching finish, 9/64" dia. holes on 3/16" centers, 51% open

MOUNTING

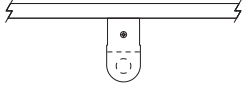
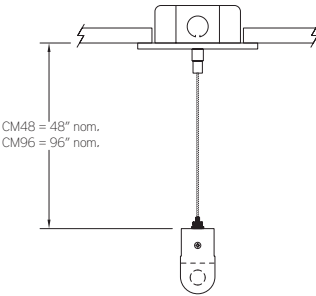
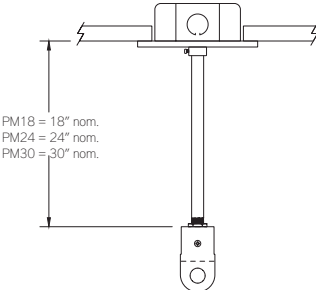
	ORDERING CODE	DESCRIPTION
	SM	<p>SURFACE MOUNT</p> <p>Use appropriate fastener through $\varnothing 3/16"$ holes in housing</p>
 <p>CM48 = 48" nom. CM96 = 96" nom.</p>	CM48 and CM96	<p>CABLE MOUNT</p> <p>Mounting option includes:</p> <ul style="list-style-type: none"> • $\varnothing 1/16"$ x 48" (CM48) or 96" (CM96) aircraft cables • 18 gauge x 60" (CM48) or 102" (CM96) SJT power cable (in coordinating finish) • Bracket bars • $\varnothing 5"$ white power feed canopy • $\varnothing 2"$ white canopy • Ceiling couplers • Low profile cable grippers
 <p>PM18 = 18" nom. PM24 = 24" nom. PM30 = 30" nom.</p>	PM18, PM24, PM30	<p>PENDANT MOUNT</p> <p>Mounting option includes:</p> <ul style="list-style-type: none"> • $\varnothing 1/2"$ x 18" (PM18), 24" (PM24) or 30" (PM30) white steel stems • Bracket bars • $\varnothing 5"$ white canopies with integrated slip ring • Hex nuts